

# Product sheet

## Miniature connector



Product	<b>Contacts: 12, Male panel mount connector, solder, with UL approval</b>	Area	<b>M16 IP67 Series 423/ 723/ 425</b>
Pole	<b>12</b>	Article number	<b>09 0131 00 12</b>

### Illustration



### Scale drawing

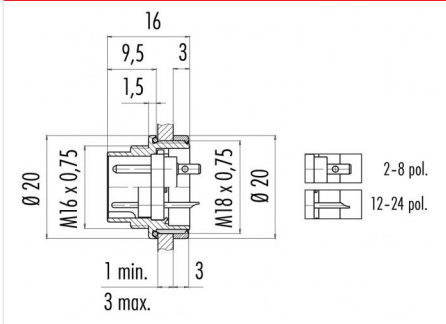

### Contact Arrangement

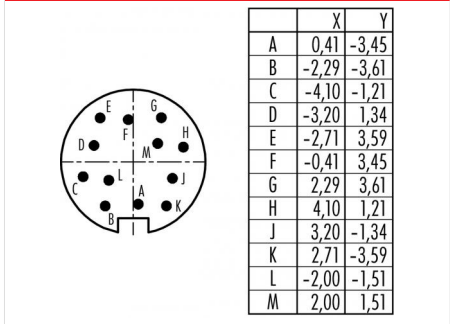

You can find the assembly instruction on the next page.

## Technical data

### Common values

Connector Design	Male panel mount connector
Connector locking system	screw
Termination	Solder
Wire gauge (mm)	0.25 mm <sup>2</sup>
Wire gauge (AWG)	24
Upper temperature	95 °C
Lower temperature	-40 °C

### Electrical values

Rated voltage	60 V
Rated impulse voltage	500 V
Pollution degree	1
Overvoltage category	I
Material group	III
Rated current (40°C)	3 A
Volume resistivity	≤ 3 mΩ
EMV compliance	shielded
Degree of protection	IP67
Mechanical operation	> 500 mating cycles

### Material

Material of contact	CuZn (Brass)
Contact plating	Au (Gold)
Material of contact body	PBT (UL 94 V-0)
Material of housing	Nickel-plated zinc die casting

Contacts: 12, Male panel mount connector, solder, gold plated contacts, with UL approval



Product

Contacts: 12, Male panel mount connector,  
solder, with UL approval

Area  
Article number

M16 IP67 Series 423/ 723/ 425  
09 0131 00 12

Pole

Installation instructions / Mounting cutout

