

Product	Contacts: 4, female panel mount connector angled, front mounting, with shielding sheet, dip-solder	Area	M8 Series 768/718
Pole	4	Article number	09 3420 82 04

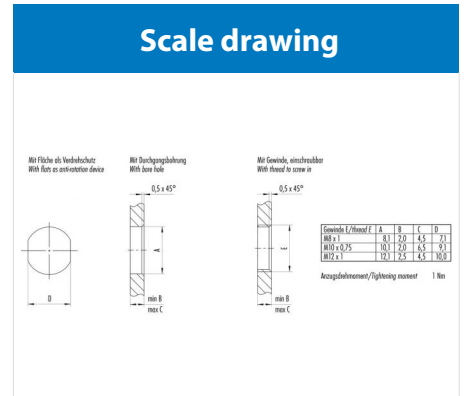
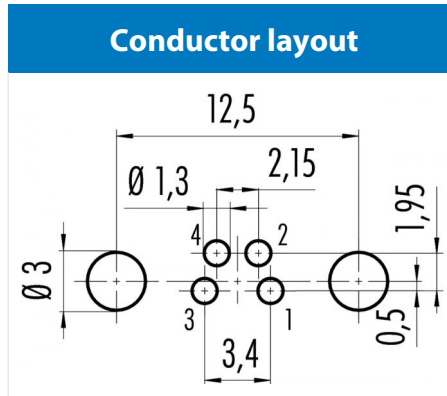
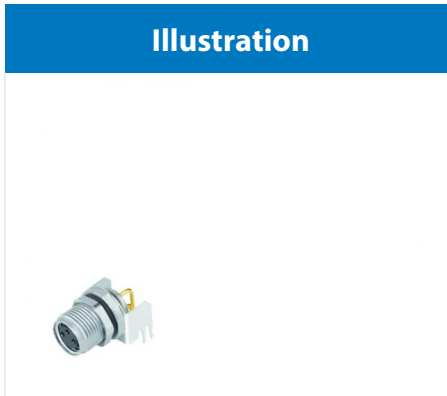

Technical data

Common values

Connector Design	Female panel mount connector
Connector locking system	screw
Termination	dip-solder
Wire gauge (mm)	-
Wire gauge (AWG)	-
Upper temperature	85 °C
Lower temperature	-40 °C

Electrical values

Rated voltage	30 V
Rated impulse voltage	800 V
Pollution degree	3
Overvoltage category	II
Material group	II
Rated current (40°C)	4 A
Volume resistivity	≤ 3 mΩ
Degree of protection	IP67
Mechanical operation	> 100 mating cycles

Material

Material of contact	CuSn (Bronze)
Contact plating	Au (Gold)
Material of contact body	PA (UL 94 HB)
Material of housing	Nickel-plated zinc die casting

Contacts: 4, female panel mount connector angled, front mounting, with shielding sheet