

D-Sub und High Density D-Sub Steckverbinder

D-Sub and High Density D-Sub Connectors



Seit über 25 Jahren fertigen wir Steckverbinder und elektromechanische Bauelemente. Der D-Sub Steckverbinder war das erste Steckverbinder-Produkt, das Provertha selbst entwickelt und hergestellt hat. Deshalb sind D-Sub Steckverbinder für hochwertige Anwendung wie z. B. spezielle EMV-Anforderungen weiterhin eine Kernkompetenz in Entwicklung und Fertigung mit einem breit gefächerten D-Sub Steckverbinderprogramm und innovative Produkte mit speziellem Kundennutzen:

- Quick Lock: innovatives Push-Pull Verriegelungssystem für D-Sub-Hauben
- 600 V D-Sub Steckverbinder für kompakte und wirtschaftliche Power-Anwendungen
- 360° EMI/RFI D-Sub Vollmetall-Hauben mit vibrationssicherer Zugentlastung und Schirmanschluss durch Crimpflansch-System

D-Sub Programm

- D Sub Steckverbinder für Platinenmontage: Einlöt 90° und 180°, Pressfit, SMT
- D Sub Steckverbinder für Kabelmontage: IDC, Crimp, Handlöt
- Mischpol D-Substeckverbinder: Einlöt 90° und 180°, Crimp, Handlöt
- 600 V D-Sub Steckverbinder für Power-Applikationen
- High Density D-Sub Steckverbinder
- DualPort D-Sub Steckverbinder
- Filter D-Sub -Steckverbinder und -Technologien, die EMV Störungen beseitigen.
- D-Sub Kunststoffhauben
- 360° EMI/RFI D-Sub Vollmetallhauben für hohe EMV-Anforderungen in der Industrieautomation und Bahntechnik
- Push-Pull D-Sub Verriegelungssystem: Quick Lock
- Zubehör: EMV- und Staub-Schutzkappen, Sechskant-Gewindeschrauben

For over 25 years we have been producing connectors and electromechanical components. Our products offer solutions for technical problems and make sure that no breakdowns through connector systems occur during the operation of high quality equipment.

The D-Sub connectors developed for performance applications with for example special EMC requirements are still a core competence in design and manufacturing with a broad product range of D-Sub connectors and innovative products with special customer benefits:

- Quick Lock: innovative push-pull locking system for D-Sub hoods
- 600 V D-Sub connectors for compact and economical power applications
- 360° EMI/RFI D-Sub die cast hoods with crimp flange system for vibration-proof cable strain relief and shield connection

D-Sub Product range

- D Sub Connectors for PCB assembly: solder pin 90° and 180°, Pressfit, SMT
- D Sub Connectors for cable assembly: IDC, crimp, hand solder
- Mixed layout D-Sub connectors: solder pin 90° and 180°, crimp and hand solder
- 600 V D-Sub Connectors for Power applications
- High Density D-Sub Connectors
- DualPort D-Sub Connectors
- Filter D-Sub Connectors and technology (EMC noise elimination)
- D-Sub plastic hoods
- 360° EMI/RFI D-Sub die cast hoods for high EMC requirements in industrial automation and railway systems
- Push-Pull D-Sub locking system: Quick Lock
- Accessories: EMC and dust protection caps, hexagon screws

D-Subminiatur Steckverbinder DIN41652 – IEC48B

D-Sub connectors DIN41652 – IEC48B

Technische Daten

Isolierkörper:

thermoplastischer Kunststoff,
glasfaserverstärkt (PBTP),
flammhemmend,
nach UL 94 V-O

Kontakte:

Ms- und Cu-Legierung

Kontaktoberfläche:

Hartvergoldet über Ni Sperrschicht
oder selektiv-vergoldet
(je nach Ausführung)

Gehäuse:

Stahlblech, verzinkt und gelb
chromatiert oder verzinkt

Steck- und Ziehkraft je Buchse:

0,3 - 0,7 N

Kriech- und Luftstrecke:

≥ 0,9 mm nach VDE 0110

Prüfspannung:

1 KV / AC

Durchgangswiderstand:

≤ 10 m Ω

Isolationswiderstand:

1010 Ω

Betriebsstrom:

5 A (siehe Derating Diagramm)

Temperaturbereich:

-55° C bis +125° C

Anschlußarten:

Lötkehl
Gerade Einlötkontakte
Abgewinkelte Einlötkontakte
Wire Wrap 0,6 x 0,6 mm
Crimp 0,032 - 0,56 mm²
Schneidklemmen
Einpresskontakte

Güteklassen:

1 = 500 Steckzyklen
2 = 200 Steckzyklen
3 = 50 Steckzyklen

Technical data

Insulator material:

Glass fibre reinforced
polybutylene-terephthalate (PBTP),
self-extinguishing,
UL 94 V-O rated

Contact material:

Brass and Copper alloy

Plating:

Gold over Nickel, or selective Gold

Shell:

Steel, zinc-plated and
yellow-chromated or tin-plated

Mating and unmating force:

0.3 - 0.7 N

Air and creepage distance:

≥ 0.9 mm, VDE 0110 rated

Test voltage:

1 KV / AC

Contact resistance:

≤ 10 m Ω

Insulation resistance:

1010 Ω

Current rating:

5 A

Temperature range:

-55° C to +125° C

Termination types:

solder pot
Straight dip-solder
Dip-solder 90°
Wire wrap 0.6 x 0.6 mm
Crimp 0.032 - 0.56 mm²
IDC
Press-fit contacts

Quality classes:

Class 1 = 500 mating cycles
Class 2 = 200 mating cycles
Class 3 = 50 mating cycles

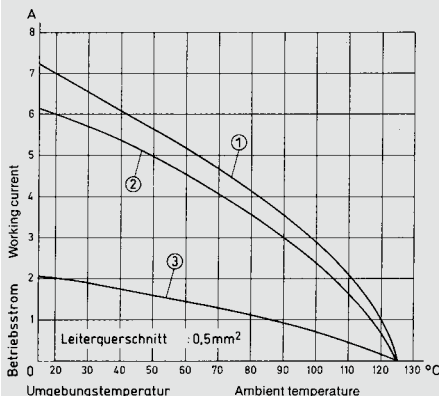

Derating-Diagramm

Die Strombelastbarkeit von Steckverbindern wird durch die thermische Belastbarkeit der Werkstoffe der Kontaktelemente einschließlich Anschlüsse und der Isolierteile begrenzt. Die Derating-Kurve gilt daher für Ströme, die dauernd, nicht intermitierend, durch jedes Kontaktelement der Steckverbindung gleichzeitig fließen dürfen, ohne daß die obere zulässige Grenztemperatur überschritten wird.

Meß- und Prüfverfahren nach

DIN IEC 60512, Teil 3.

Beispiel: 25poliger Steckverbinder

- ① gedrehte Kontakte
- ② gestanzte Kontakte
- ③ Schneidklemmkontakte

Current carrying capacity

The current carrying capacity is limited by maximum temperature of materials for inserts and contacts including terminals. The current capacity-curve is valid for continuous, not interrupted current-loaded contacts of connectors when simultaneous power on all contacts is given, without exceeding the maximum temperature.

Control and test procedures according to DIN IEC 60512, part 3.

Example: 25 way connector

- ① Turned contacts
- ② Stamped contacts
- ③ Insulation displacement contacts

D-Subminiatur Steckverbinder

D-Sub connector foot prints

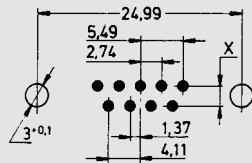

9-polig / contacts

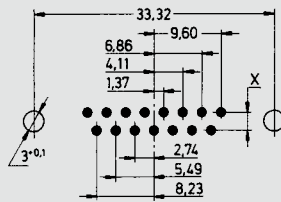
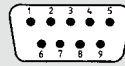

15-polig / contacts

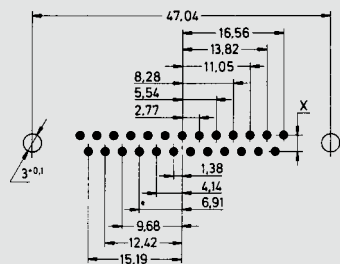
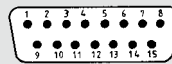

25-polig / contacts

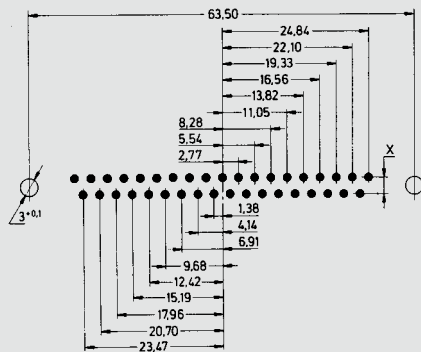
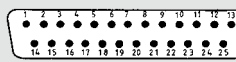

37-polig / contacts

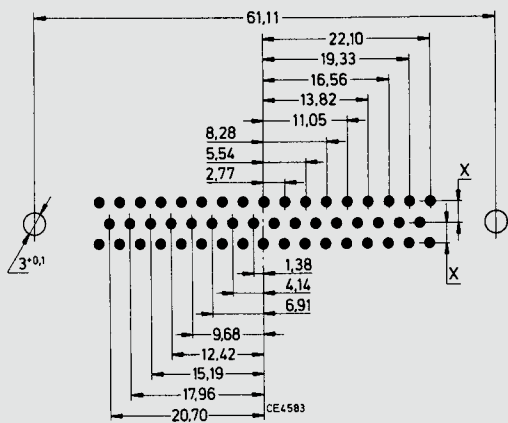
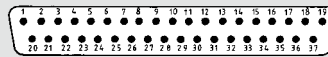

50-polig / contacts

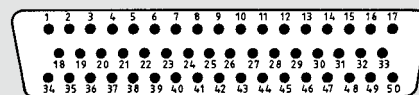

Befestigungswinkel / Mounting bracket

Kunststoffwinkel / Plastic bracket

mit Durchgangsloch 3.2 mm
through hole 3.2 mm

Erdungsblech mit Rasterclip für
Bohrung 3.1+0.1 mm

Erdungsblech mit
Durchgangsloch 3.2 mm

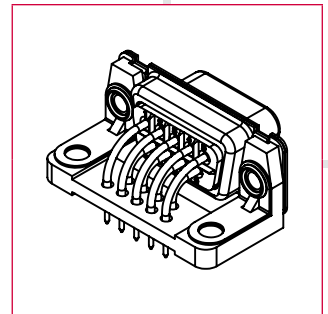
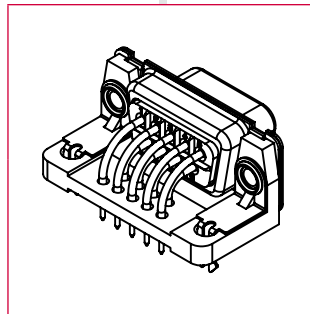
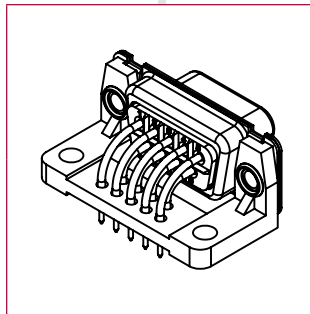

**Befestigungs-
ausführung
Mounting Style**

Planer Gewindeniet UNC4-40 (4) oder M3 (3)
oder Durchgangsloch 3,1 mm (0)
flush threaded rivet UNC 4-40 (4)
or M3 (3) or through hole 3,1 mm (0)

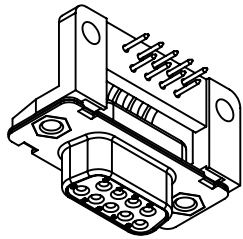

4B

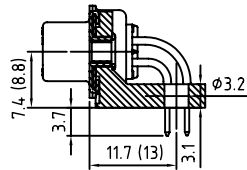

R4B

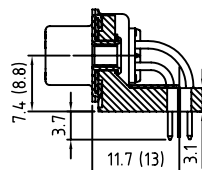

E4B

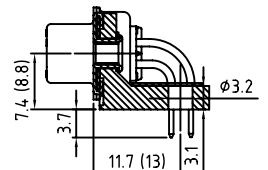

Gewindebolzen
UNC4-40 (4) oder M3 (3)
Threaded bolt
UNC4-40 (4) or M3 (3)

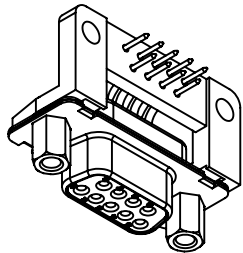

4BA

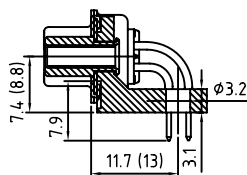

R4BA

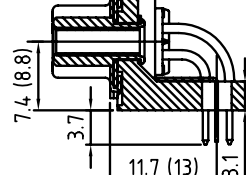

E4BA

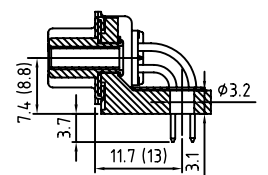

Gleitverriegelungsbolzen
Slide locking bolts

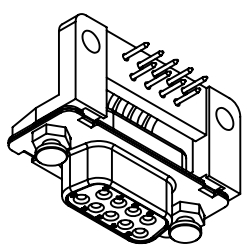

56B

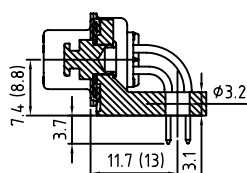

R56B

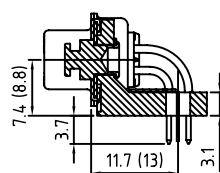

E56B

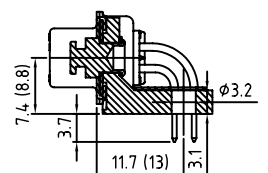

Befestigungswinkel / Mounting bracket

Metallwinkel / Metal bracket

mit Durchgangsloch
3.4 mm

mit Rasterclip für Bohrung
3.1+0.1 mm

Verschraubung

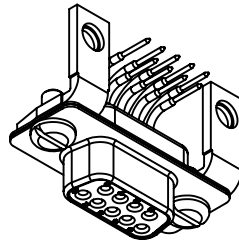
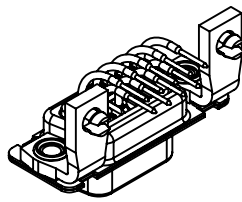
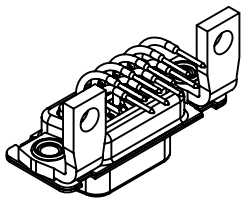

48

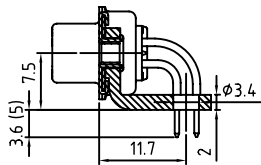

R48

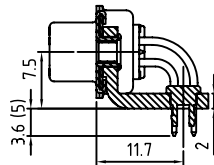

S8

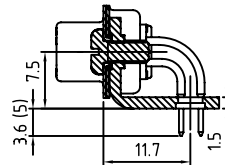

48A

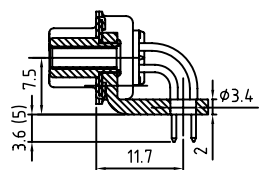

R48A

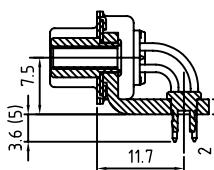

S448

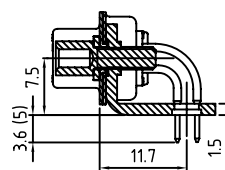

568

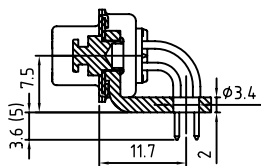

R568

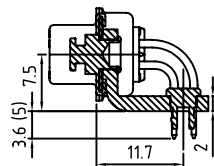

S568

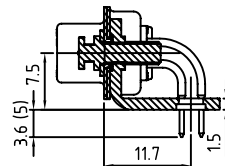

! Maße für 50-pol Kunststoffwinkel
8,8 mm anstatt 7,4 mm und 13 mm
anstatt 11,7 mm.

Bei M3-Gewinde bitte die 4 in der
Art.-Nr. gegen eine 3 austauschen.

Bitte die Bestellnummer der
gewünschten Ausführung an die
Artikelnummer des Standard-Steck-
verbinders anhängen,
z.B. ST 25 66 G 3 R 4 B.

Rasterclip für Bohrung $\phi 3,1 \text{ mm} + 0,1$
in 1,6 mm starker Leiterplatte.

*Dimension for plastic bracket pole 50
8,8 mm instead of 11,7 mm and 13
mm instead of 11,7 mm.*

*For M3 thread please replace the
number 4 of the part no. by the
number 3.*

*Please add order code to part no. of
standard connectors, e.g. ST 25 66 G
3 R 4 B.*

*Locking clip fixing hole diameter 3,1
mm + 0,1 1,6 mm thick board.*

Ausführungen

Versions

Gewindeniet Threaded rivet	Gewinde	Für Bohrung / for hole
		H
		K
		Leiterplattenstärke PCB thickness

Combi-/Boardlockniet Combi-/Boardlock rivet	UNC4-40 / M3	3,1 + 0,1
		6,2 / 6,6
		6,2 / 6,6 / 7,4 / 9 / 11 / 14 / 16
		1,6

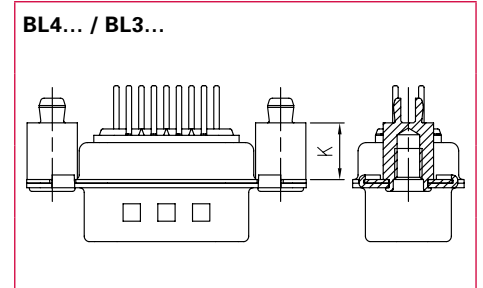
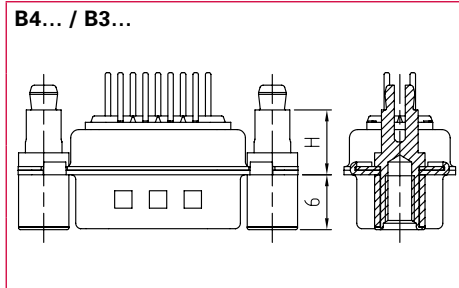

Combi-/Boardlockniet Combi-/Boardlock rivet	UNC4-40 / M3	3,1 + 0,1
		6,2 / 6,6
		6,2 / 6,6 / 8
		1,5 - 3,5

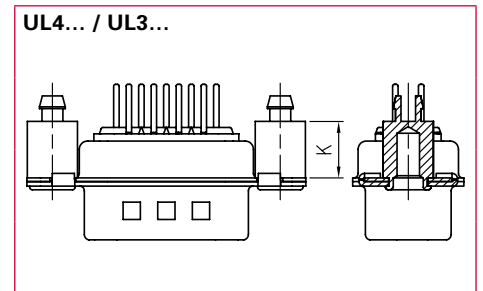
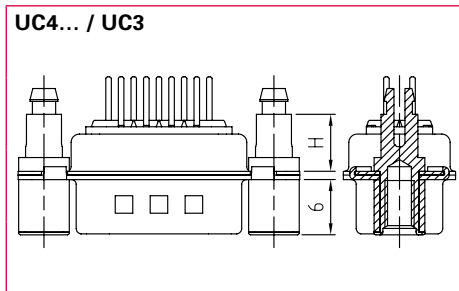

Gewindeniet Threaded rivet	UNC4-40 / M3	3,1 + 0,1
		5,5 / 6,2
		5,5 / 6,2

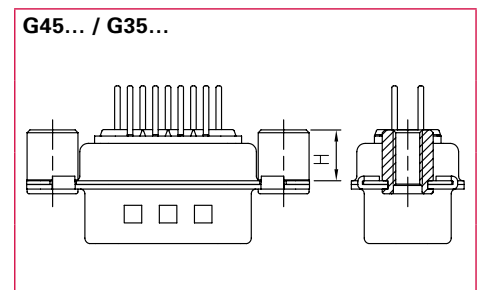
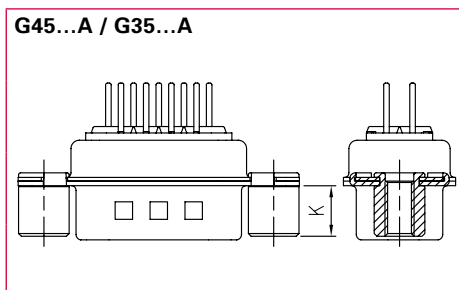

Gewindeniet Threaded rivet	UNC4-40 / M3	3,1 + 1,0
		2,8

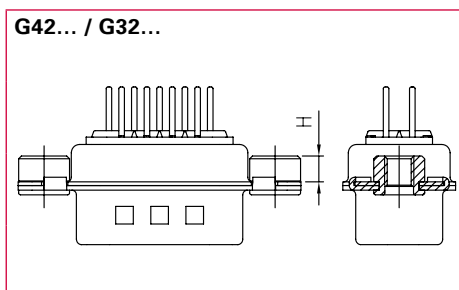

Bemerkungen / Coments:

- Standard:
G45... / G35... – H = 5.5 mm
G46... / G36... – H = 6.2 mm
- Crimp:
CG45... / CG35...
- HD D-Sub (Seite 22)
H45... / H35... – H = 6.2 mm

Schwimmende Befestigung Float mount		

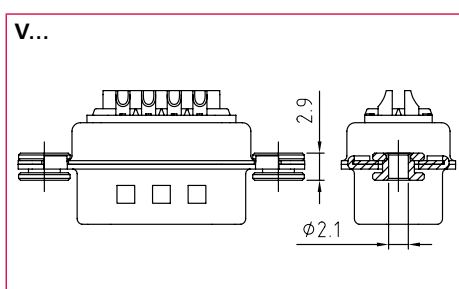

- Frontseitig plan / plane on front side:
G45DNT... / G35DNT...
G45NT... / G35NT...

Doppelstock Steckverbinder mit gestanzten Kontakten

Dual port connectors with stamped contacts

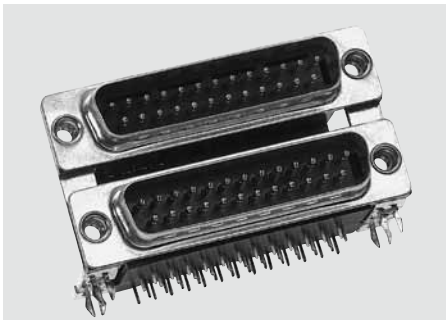

- Platzvorteil durch zwei Steckverbinder auf nahezu gleicher Platinengrundfläche
- Zahlreiche Kombinationsmöglichkeiten
- D-Sub Abstandsmaß 15,88 mm. Sondermaße auf Anfrage
- Isolierkörper nach UL 94-VO geprüft
- Gütestufe 3

- Space saving due to two connectors being almost able to occupy one board connector layout
- Numerous connector combinations are possible
- D-Sub connector distance height of 15.88 mm
- Special connector distance on request
- Connector insulator tested to UL 94-VO
- Contacts are class 3 (50 mating cycles)

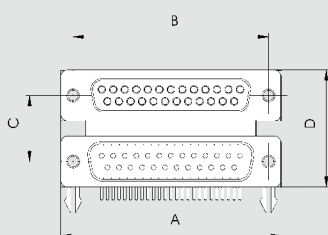
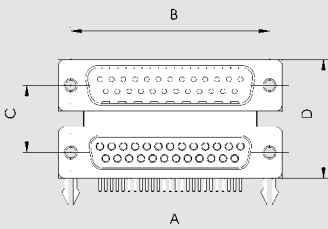
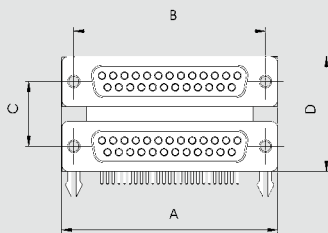
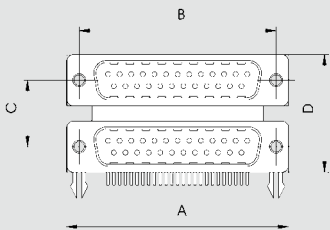

Polzahl Size	Stift – Stift Pin – Pin
09	DP 09 P 09 P R4B
15	DP 15 P 15 P R4B
25	DP 25 P 25 P R4B

Polzahl Size	Buchse – Buchse Socket – Socket
09	DP 09 S 09 S R4B
15	DP 15 S 15 S R4B
25	DP 25 S 25 S R4B

Polzahl Size	Stift – Buchse Pin – Socket
09	DP 09 P 09 S R4B
15	DP 15 P 15 S R4B
25	DP 25 P 25 S R4B

Polzahl Size	Buchse – Stift Socket – Pin
09	DP 09 S 09 P R4B
15	DP 15 S 15 P R4B
25	DP 25 S 25 P R4B

Abmessungen / Dimensions

Polzahl Size	9	15	25
A	30.6	39.0	52.8
B	25.0	33.3	47.0
C*	15.88	15.88	15.88
D*	28.4	28.4	28.4

*Andere Dimensionen auf Anfrage
*Other dimensions on request

! Alle Doppelstock-Steckverbinder sind montiert mit Metallwinkel, Rastclip und UNC 4-40 Gewindeniet.
Sonderversionen auf Anfrage.

All dual port connectors are assembled with metal angle brackets, locking clips and UNC 4-40 threads.
Special versions on request.