

Product sheet

Miniature connector



Product	Contacts: 6 DIN, Male panel mount connector, crimp, screwed from front	Area	M16 IP67 Series 423/ 723/ 425
Pole	6 DIN	Article number	09 0123 780 06

Illustration



Scale drawing

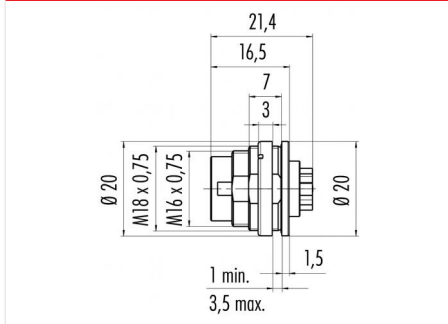

Contact Arrangement

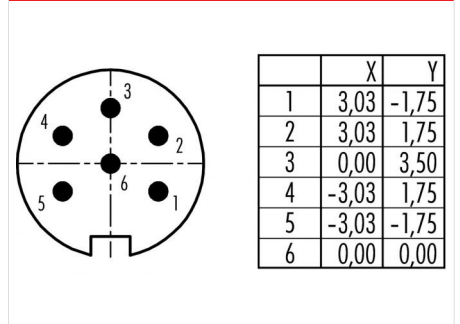

Technical data

Common values

Connector Design	Male panel mount connector
Connector locking system	screw
Termination	Crimp
Wire gauge (mm)	0.14 -1.0 mm ²
Wire gauge (AWG)	26-18
Cable outlet	-
Upper temperature	95 °C
Lower temperature	-40 °C

Electrical values

Rated voltage	250 V
Rated impulse voltage	1500 V
Pollution degree	1
Overvoltage category	I
Material group	III
Rated current (40°C)	5 A
Volume resistivity	≤ 5 mΩ
EMV compliance	not shielded
Degree of protection	IP67
Mechanical operation	> 500 mating cycles

Material

Material of contact	CuSn (Bronze)
Contact plating	Ag (Silver)
Material of contact body	PBT (UL 94 V-0)
Material of housing	CuZn (Brass nickel-plated)

Contacts: 6 DIN, Male panel mount connector, crimp, screwed from front

