

Product	<b>Contacts 3: Female angled connector, overmoulded, M5x0.5</b>	Area	<b>M5 Series 707</b>
Pole	<b>3</b>	Article number	<b>79 3104 55 03</b>

### Illustration

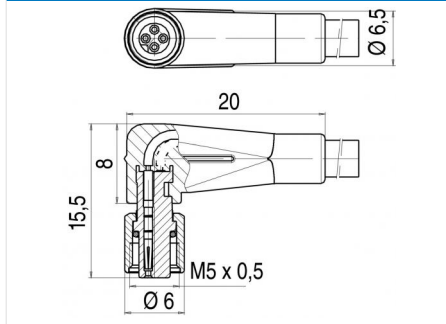

### Scale drawing



### Contact Arrangement

	X	Y
1	0,63	-0,63
2	-	-
3	-0,63	0,63
4	0,63	0,63

1 braun/brown  
 2 nicht konfektioniert/not assembled  
 3 blau/blue  
 4 schwarz/black

## Technical data

### Common values

Connector Design	Female angled connector
Connector locking system	screw
Termination	crimp, injection-moulded cable
Wire gauge (mm)	0.14 mm <sup>2</sup>
Wire gauge (AWG)	26
Cable outlet	-
Upper temperature	80 °C
Lower temperature	-25 °C

### Electrical values

Rated voltage	60 V
Rated impulse voltage	800 V
Pollution degree	3
Overvoltage category	II
Material group	I
Rated current (40°C)	1 A
Volume resistivity	≤ 3 mΩ
EMV compliance	nicht geschirmt
Degree of protection	IP67
Mechanical operation	> 100 mating cycles

### Cable data

material housing	PUR
Insulation single lead	PVC
Single lead structure	18 x 0.1
Cable sheath Ø	3.1
Conductor resistance	148Ω/Km
Temperature range cable movable c from	-5
Temperature range cable movable c to	80
Temperature range cable fixed c from	-25
Temperature range cable fixed c to	80

### Material

Material of contact	CuSn (Bronze)
Contact plating	Au (Gold)
Material of contact body	PUR
Material of housing	PUR

Contacts: 3, Cable length: 5, Cable: 3 x 0.14 mm<sup>2</sup> PUR, female angled connector, overmoulded, M5 x 0.5