

# Product sheet

## Miniature connector



Product	<b>Contacts: 4, female panel mount connector, crimp</b>	Area	<b>M16 IP67 Series 423/ 723/ 425</b>
Pole	<b>4</b>	Article number	<b>09 0112 700 04</b>

### Illustration



### Scale drawing

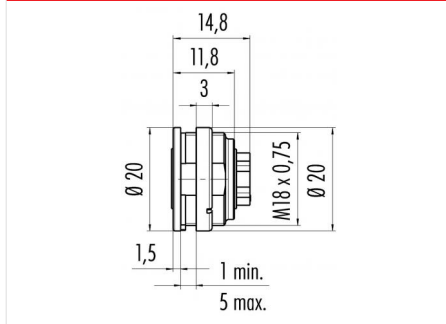

### Contact Arrangement

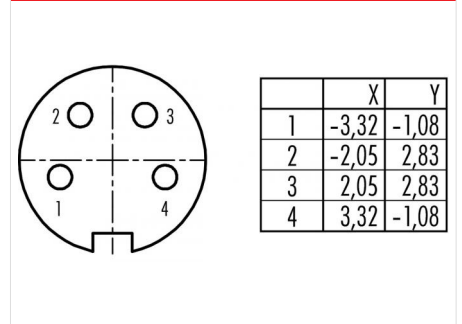

## Technical data

### Common values

Connector Design	Female panel mount connector
Connector locking system	screw
Termination	Crimp
Wire gauge (mm)	0.14 -1.0 mm <sup>2</sup>
Wire gauge (AWG)	26-18
Cable outlet	-
Upper temperature	95 °C
Lower temperature	-40 °C

### Electrical values

Rated voltage	250 V
Rated impulse voltage	1500 V
Pollution degree	1
Overvoltage category	I
Material group	III
Rated current (40°C)	6 A
Volume resistivity	≤ 5 mΩ
EMV compliance	not shielded
Degree of protection	IP67
Mechanical operation	> 500 mating cycles

### Material

Material of contact	CuSn (Bronze)
Contact plating	Ag (Silver)
Material of contact body	PBT (UL 94 V-0)
Material of housing	CuZn (Brass nickel-plated)

Contacts: 4, female panel mount connector, crimp

