

Product
Pole

Contacts 8, cable plug connector, green
8

Area
Article number

Snap-in IP67 Series 620
99 9225 070 08

Illustration



Scale drawing

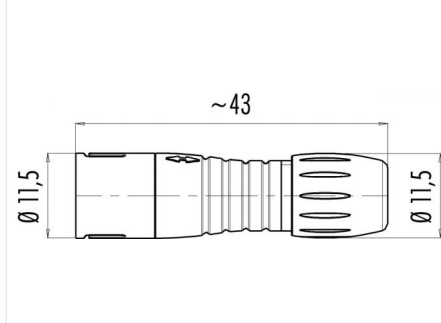

Contact Arrangement

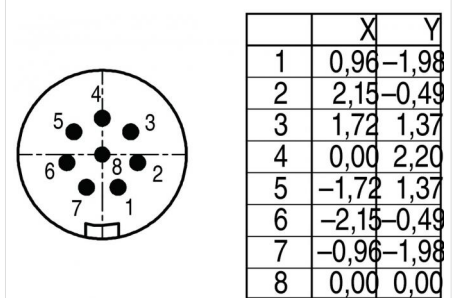

You can find the item description on the next page.

Technical data

Common values

Connector Design	Cable plug connector
Connector locking system	Snap
Wire gauge (mm)	0.25 mm ²
Wire gauge (AWG)	24
Cable outlet	3 - 5 mm
Upper temperature	85 °C
Lower temperature	-40 °C

Cable data

material housing	-
Insulation single lead	-
Single lead structure	-
Conductor resistance	-

Electrical values

Rated voltage	63 V
Rated impulse voltage	800 V
Pollution degree	2
Overvoltage category	II
Material group	II
Rated current (40°C)	1 A
Volume resistivity	≤ 3 mΩ
EMV compliance	not shielded
Degree of protection	IP67
Mechanical operation	> 500 mating cycles

Material

Material of contact	CuZn (Brass)
Contact plating	Au (Gold)
Material of contact body	PA (UL 94 V-0)
Material of housing	PA (UL 94 V-0)

Contacts: 8, Cable plug connector, green

Product
Pole

Contacts 8, cable plug connector, green
8

Area
Article number

Snap-in IP67 Series 620
99 9225 070 08

Item description

