

Product sheet

Subminiature connector



Product Pole	Contacts: 8, Cable plug connector 8	Area Article number	M9 IP40 Series 711 99 0479 100 08
--------------	---	---------------------	---

Illustration



Scale drawing

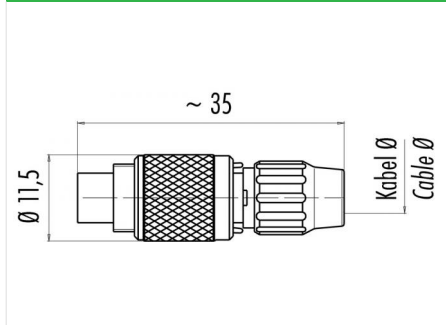

Contact Arrangement

	X	Y
1	0,90	-1,65
2	1,85	-0,35
3	1,45	1,20
4	0,00	1,85
5	-1,45	1,20
6	-1,85	-0,35
7	-0,90	-1,65
8	0,00	0,00

You can find the item description on the next page.

Technical data

Common values

Connector Design	Cable plug connector
Connector locking system	screw
Termination	Solder
Wire gauge (mm)	0.14 mm ²
Wire gauge (AWG)	26
Cable outlet	3 - 4 mm
Upper temperature	85 °C
Lower temperature	-40 °C

Cable data

material housing	-
Insulation single lead	-
Single lead structure	-
Conductor resistance	-

Electrical values

Rated voltage	125 V
Rated impulse voltage	1500 V
Pollution degree	1
Overvoltage category	II
Material group	III
Rated current (40°C)	1 A
Volume resistivity	≤ 3 mΩ
EMV compliance	not shieldable
Degree of protection	IP40
Mechanical operation	> 500 mating cycles

Material

Material of contact	CuZn (Brass)
Contact plating	Au (Gold)
Material of contact body	PA (UL 94 V-0)
Material of housing	PA (UL 94 VH-B)

Contacts: 8, cable plug connector, cable outlet 3 -4 mm

Product
Pole

Contacts: 8, Cable plug connector
8

Area
Article number

M9 IP40 Series 711
99 0479 100 08

Item description

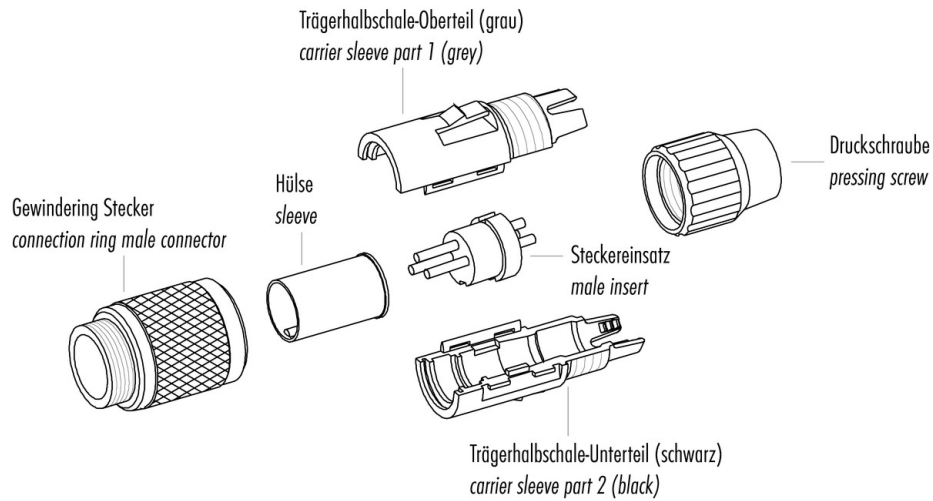

Achtung: max. Drehmoment des Gewindinges im Flanschsteckverbinder: 50cNm (handfest)

Attention: max. torque of ring nut in socket connector: 50cNm (manual adjustment)