

Product	<b>Contacts 4: Connecting cord, cable plug connector M8x1-female cable connector, M12x1, 4x0.25 PUR</b>	Area	<b>Connecting cords Series 765</b>
Pole	<b>4</b>	Article number	<b>79 5073 20 04</b>

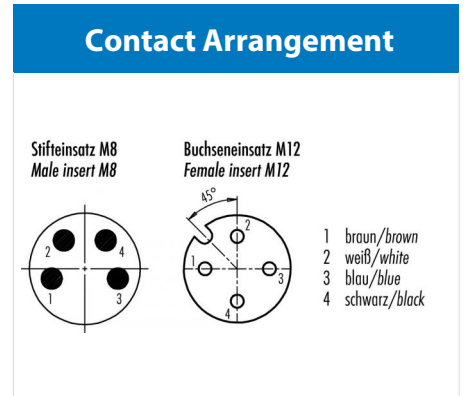
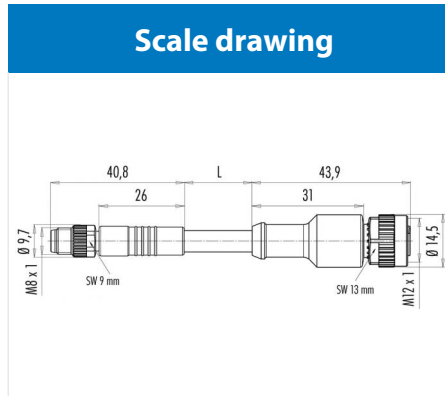
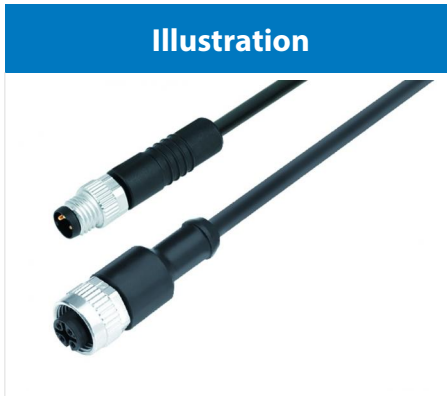

## Technical data

### Common values

Connector Design	Connecting cord
Connector locking system	screw
Termination	crimp, injection-moulded cable
Wire gauge (mm)	0.25 mm <sup>2</sup>
Wire gauge (AWG)	24
Upper temperature	85 °C
Lower temperature	-25 °C

### Electrical values

Rated voltage	30 V
Rated impulse voltage	800 V
Pollution degree	3
Overvoltage category	II
Material group	II
Rated current (40°C)	4 A
Volume resistivity	≤ 3 mΩ
EMV compliance	nicht geschirmt
Degree of protection	IP67
Mechanical operation	> 100 mating cycles

### Material

Material of contact	Pin/ CuZn (brass), socket/ CuSn (bronze)
Contact plating	Au (Gold)
Material of contact body	PUR
Material of housing	PUR

Contacts 4: Connecting cord, 2m, cable plug connector M8 x 1 - female cable connector M12 x 1, cable 3 x 0.25 PUR