



inserts:	page:
CD 40 poles + ⊕	57
CDD 72 poles + ⊕	70
CDS 27 poles + ⊕	80
CSH 16 poles + ⊕	93
CNE, CSE 16 poles + ⊕	106
CCE 16 poles + ⊕	112
CSS 16 poles + ⊕	124
CT, CTSE (16A) * .. 16 poles + ⊕	132
CQE 32 poles + ⊕	140
CQEE 40 poles + ⊕	146
CMCE 6+2 (aux) poles + ⊕	150
CME, CMSH.. 6+2 (aux) poles + ⊕	151
CP 6 poles + ⊕	162
CX 6/36 and 12/2 poles + ⊕	170-171
CX 4/0 and 4/2 poles + ⊕	172
MIXO 4 modules	179-215

*) only for standard insulating version TCHI

insert centre distance: 77,5 x 27 mm

housings with double lever

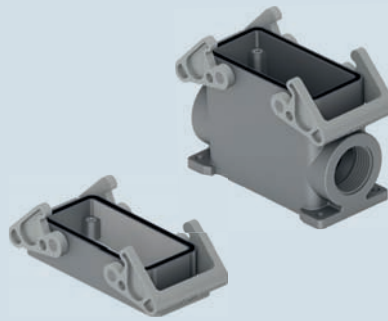

hoods with 4 pegs



description	part No.	entry M
bulkhead mounting housing with thermoplastic levers	TCHI 16	
surface mounting housing with thermoplastic levers	TMAP 16.32	32
surface mounting housing with thermoplastic levers	TMAP 16.40	40
with pegs, side entry		
with pegs, side entry		
with pegs, top entry		
with pegs, top entry		

part No.	entry M

part No.	entry M

panel cut-out for bulkhead mounting housing in mm

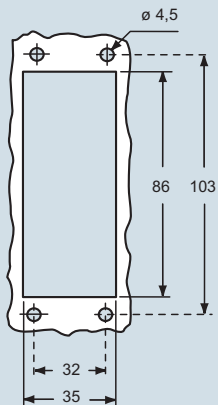

dimensions in mm

TCHI 16

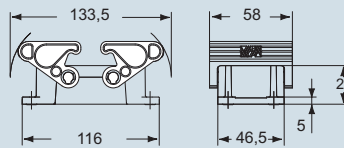

TMAP 16.32 and TMAP 16.40

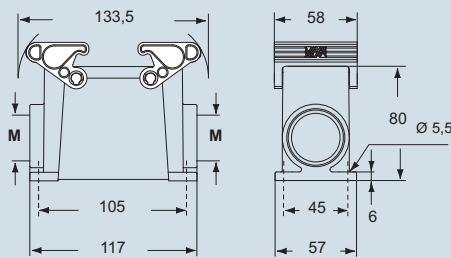

dimensions in mm

TMAO 16.32 and TMAO 16.40

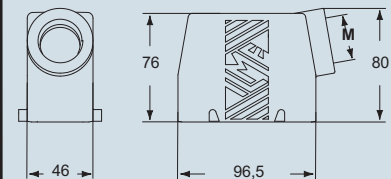

TMAV 16.32 and TMAV 16.40

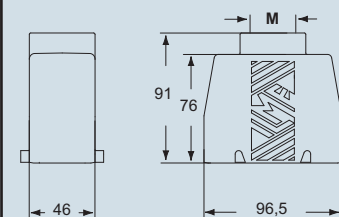

The surface mounting, high construction housings are supplied with an open threaded entry and diametrically opposite a closed threaded entry which can be opened by the user if required (with suitable tool).

CRUS Type 12



ambient temperature limits -40 °C / +90 °C

dimensions shown are not binding and may be changed without notice



inserts:	page:	hoods with double lever top entry
CD 40 poles + ⊕	57	
CDD 72 poles + ⊕	70	
CDS 27 poles + ⊕	80	
CSH 16 poles + ⊕	93	
CNE, CSE 16 poles + ⊕	106	
CCE 16 poles + ⊕	112	
CSS 16 poles + ⊕	124	
CT, CTSE (16A) * .. 16 poles + ⊕	132	
CQE 32 poles + ⊕	140	
CQEE 40 poles + ⊕	146	
CMCE 6+2 (aux) poles + ⊕	150	
CME, CMSH.. 6+2 (aux) poles + ⊕	151	
CP 6 poles + ⊕	162	
CX 6/36 and 12/2 poles + ⊕	170-171	
CX 4/0 and 4/2 poles + ⊕	172	
MIXO 4 modules	179-215	

*) only for standard insulating version TCHI

insert centre distance: 77,5 x 27 mm



NEW

covers

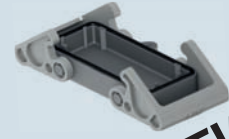

NEW

description	part No.	entry M	part No. (with eyelet)	part No. (with loop)
with thermoplastic levers and gasket	TMAV 16 G32	32		
with thermoplastic levers and gasket	TMAV 16 G40	40		
with 4 pegs			TCHC 16	TCHC 16 S
with 2 thermoplastic levers and gasket				TCHC 16 G

dimensions in mm

TMAV 16 G32 and TMAV 16 G40

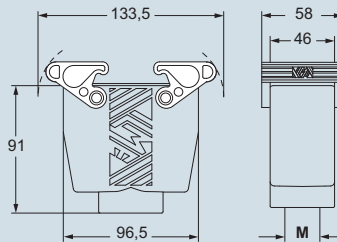

dimensions in mm

TCHC 16 (S)

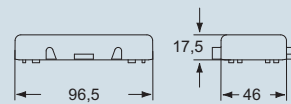

TCHC 16 G

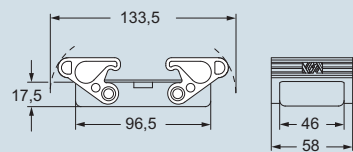

CRUS Type 12



ambient temperature limits -40 °C / +90 °C

dimensions shown are not binding and may be changed without notice

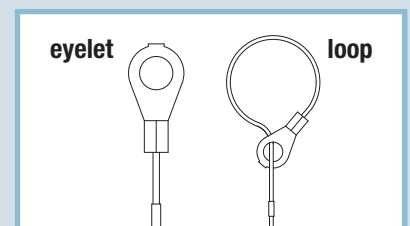

T-TYPE - size 77.27