

Product	<b>Contacts: 3+PE, male angled connector with UL approval, with die-cast threaded ring, cable outlet 8 - 10 mm, 10 - 12 mm</b>	Area	<b>7/8" Series 820</b>
Pole	<b>3+PE</b>	Article number	<b>99 2443 62 04</b>

**Illustration**

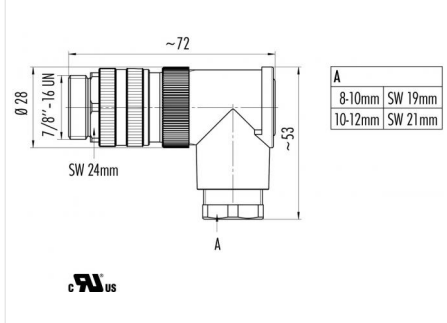

**Scale drawing**



**Contact Arrangement**

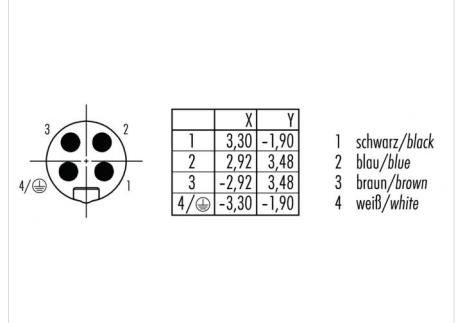

You can find the item description and assembly instruction on the next page.

**Technical data**

**Common values**

Connector Design	Male angled connector
Connector locking system	Screws 7/8" - 16 UN
Termination	Screwing
Wire gauge (mm)	1.50 mm <sup>2</sup>
Wire gauge (AWG)	16
Cable outlet	8 - 10 mm
Upper temperature	85 °C
Lower temperature	-25 °C

**Electrical values**

Rated voltage	300 V
Rated impulse voltage	4000 V
Pollution degree	3
Overvoltage category	III
Material group	III
Rated current (40°C)	9 A
Volume resistivity	≤ 3 mΩ
Degree of protection	IP67
Mechanical operation	> 50 mating cycles

**Cable data**

material housing	-
Insulation single lead	-
Single lead structure	-
Conductor resistance	-
Bending radius cable fixed	-
Bending radius cable movable	-

**Material**

Material of contact	CuZn (Brass)
Contact plating	Au (Gold)
Material of contact body	PUR, PA (UL 94 HB)
Material of housing	PBT (UL 94 V-0)

cable outlet: 8 – 10 mm, Contacts: 3+PE, male angled connector with UL approval, cross-section 1.5 mm<sup>2</sup>

Product	<b>Contacts: 3+PE, male angled connector with UL approval, with die-cast threaded ring, cable outlet 8 - 10 mm, 10 - 12 mm</b>	Area	<b>7/8" Series 820</b>
Pole	<b>3+PE</b>	Article number	<b>99 2443 62 04</b>

Item description

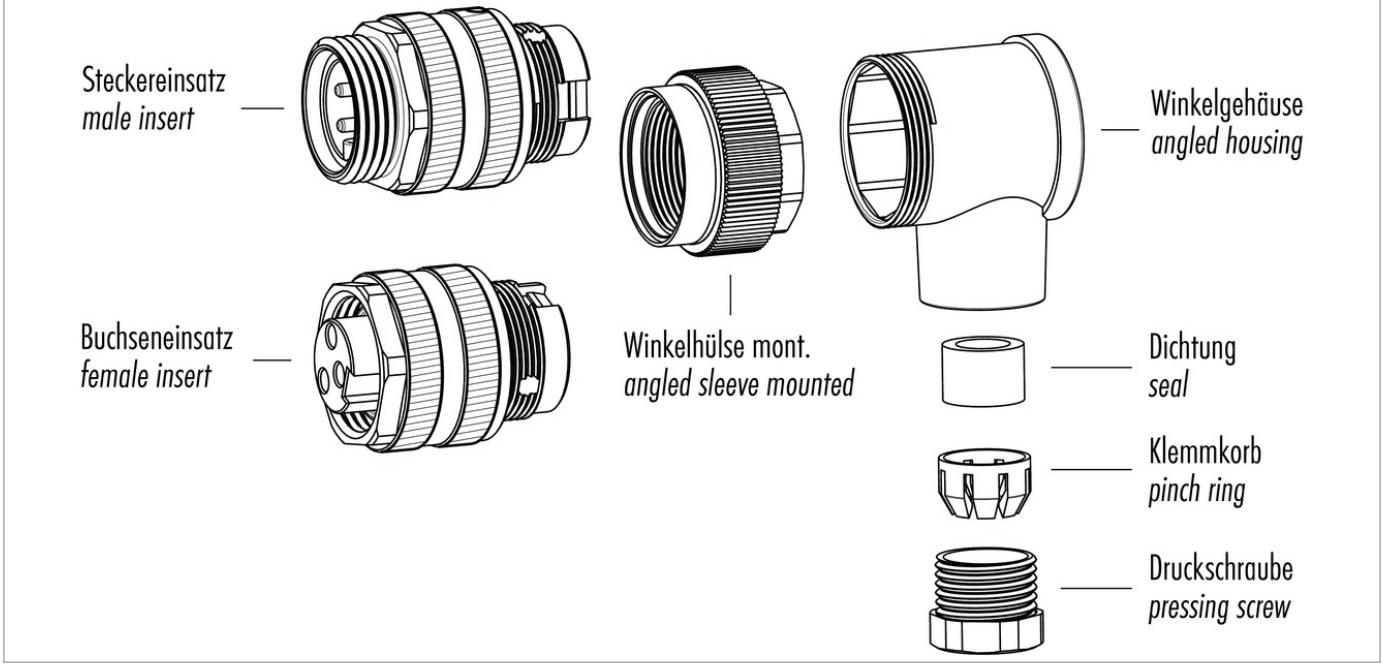

Installation instructions / Mounting cutout

