

Product sheet

Subminiature connector



Product Pole

Contacts: 7, male panel mount connector
7

Area Article number

Bayonet IP40 Series 710
09 9477 00 07

Illustration



Scale drawing

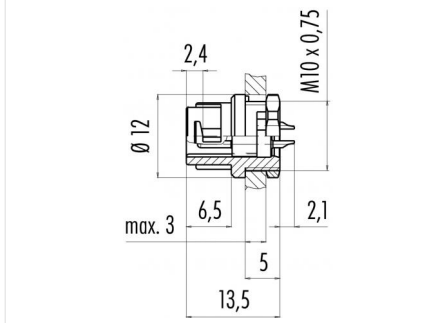

Contact Arrangement

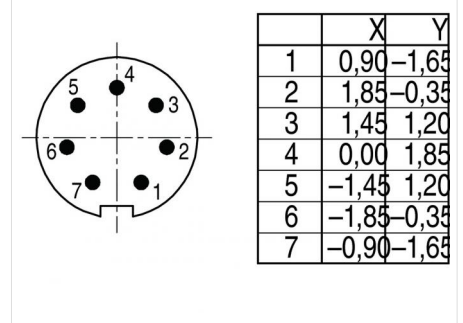

You can find the assembly instruction on the next page.

Technical data

Common values

Connector Design	Male panel mount connector
Connector locking system	Bayonet
Termination	Solder
Wire gauge (mm)	0.14 mm ²
Wire gauge (AWG)	26
Cable outlet	-
Upper temperature	85 °C
Lower temperature	-40 °C

Cable data

material housing	-
Insulation single lead	-
Single lead structure	-
Conductor resistance	-

Electrical values

Rated voltage	125 V
Rated impulse voltage	1500 V
Pollution degree	1
Overvoltage category	II
Material group	III
Rated current (40°C)	1 A
Volume resistivity	≤ 3 mΩ
EMV compliance	not shieldable
Degree of protection	IP40
Mechanical operation	> 500 mating cycles

Material

Material of contact	CuZn (Brass)
Contact plating	Au (Gold)
Material of contact body	PA (UL 94 V-0)
Material of housing	PA (UL 94 HB)

Contacts: 7, male panel mount connector

Product
Pole

Contacts: 7, male panel mount connector
7

Area
Article number

Bayonet IP40 Series 710
09 9477 00 07

Installation instructions / Mounting cutout

