

Product sheet

Subminiature connector



Product	Contacts 5, male panel mount connector IP 67, front screw connection, shielded	Area	Push-Pull IP67 Series 430
Pole	5	Article number	09 4915 081 05

Illustration



Scale drawing

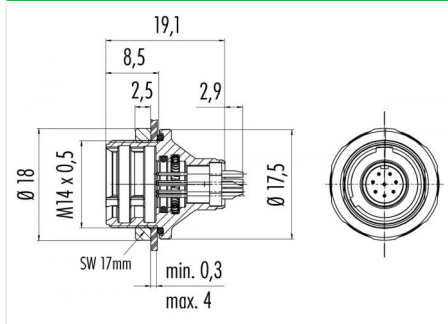

Contact Arrangement

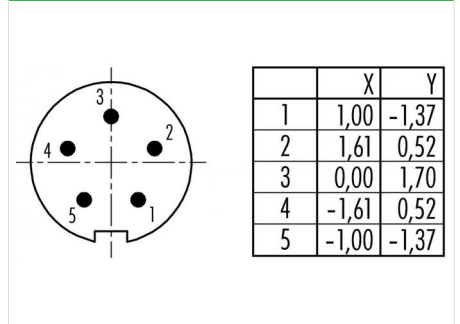

You can find the assembly instruction on the next page.

Technical data

Common values

Connector Design	Male panel mount connector
Connector locking system	Push-Pull
Termination	Solder
Wire gauge (mm)	0.25 mm ²
Wire gauge (AWG)	24
Cable outlet	-
Upper temperature	85 °C
Lower temperature	-40 °C

Electrical values

Rated voltage	125 V
Rated impulse voltage	1500 V
Pollution degree	2
Overvoltage category	I
Material group	II
Rated current (40°C)	3 A
Volume resistivity	≤ 5 mΩ
EMV compliance	shieldable
Degree of protection	IP67
Mechanical operation	> 500 mating cycles

Cable data

material housing	-
Insulation single lead	-
Single lead structure	-
Conductor resistance	-

Material

Material of contact	CuZn (Brass)
Contact plating	Au (Gold)
Material of contact body	PBT, PA
Material of housing	CuZn (Brass nickel-plated)

Contacts: 5, Male panel mount connector IP 67, front screw-connection, shielded

Product

Contacts 5, male panel mount connector IP
67, front screw connection, shielded
5

Area
Article number

Push-Pull IP67 Series 430
09 4915 081 05

Pole

Installation instructions / Mounting cutout

