

Product	Contacts: 5, Male angled connector, metal lock, screw terminal connection, with UL approval	Area	M12-A Series 713
Pole	5	Article number	99 0437 52 05

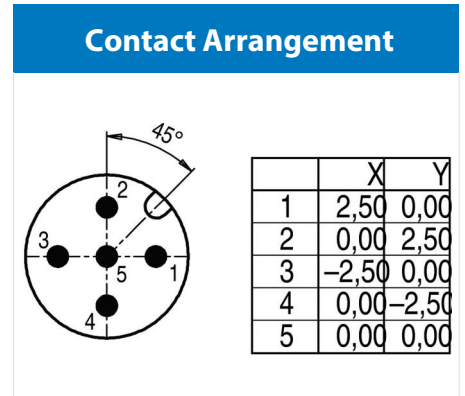
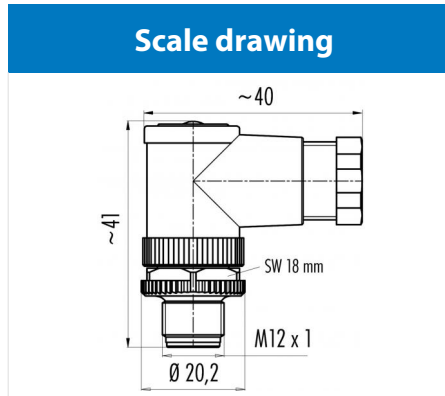

You can find the item description and assembly instruction on the next page.

Technical data

Common values

Connector Design	Male angled connector
Connector locking system	screw
Termination	Screwing
Wire gauge (mm)	0.75 mm ²
Wire gauge (AWG)	18
Cable outlet	6 - 8 mm
Upper temperature	85 °C
Lower temperature	-40 °C

Electrical values

Rated voltage	125 V
Rated impulse voltage	1500 V
Pollution degree	3
Overvoltage category	II
Material group	II
Rated current (40°C)	4 A
Volume resistivity	≤ 8 mΩ
EMV compliance	nicht geschirmt
Degree of protection	IP67
Mechanical operation	> 50 mating cycles

Material

Material of contact	CuZn (Brass)
Contact plating	CuSnZn (Optaloy)
Material of contact body	PA
Material of housing	PA

Contacts: 5, Cable outlet: 6-8 mm, male angled connector, metal lock, screw terminal connection, with UL approval

Product	Contacts: 5, Male angled connector, metal lock, screw terminal connection, with UL approval	Area	M12-A Series 713
Pole	5	Article number	99 0437 52 05

Item description

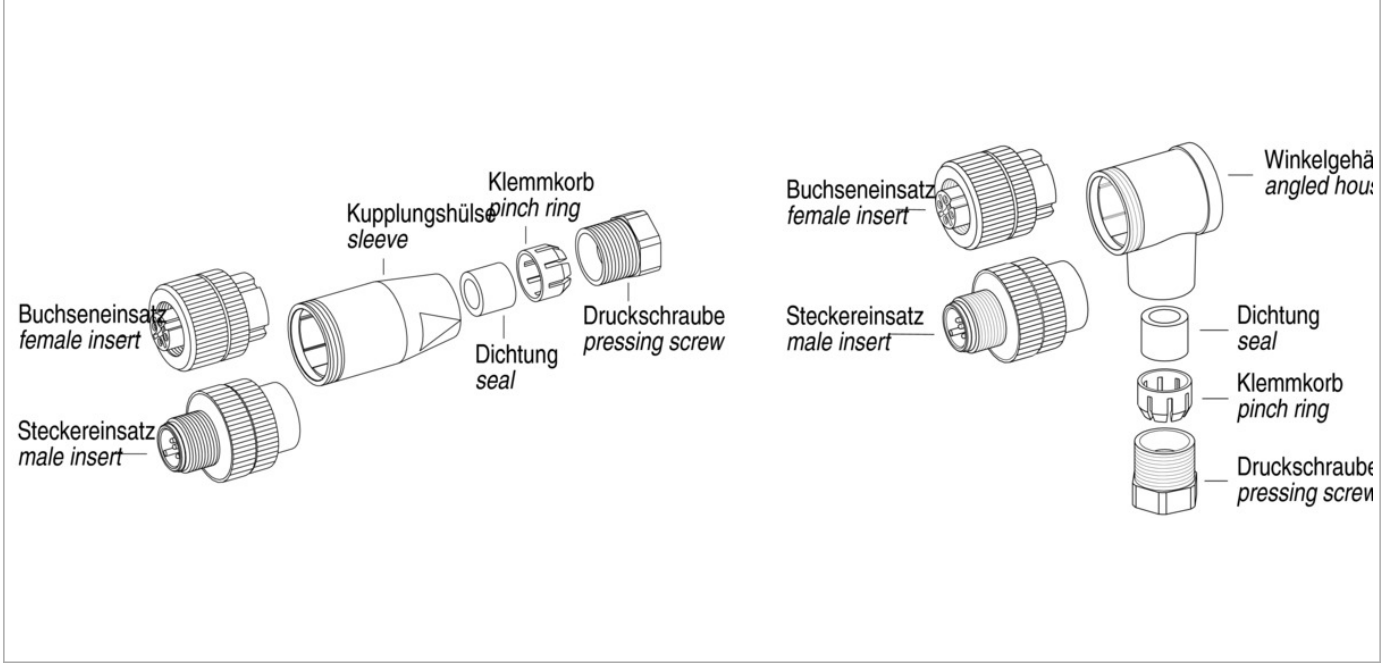

Installation instructions / Mounting cutout

