

Product	Contacts: 4, Female cable connector, shieldable, wire clamp connection, iris type spring	Area	M12-A Series 713
Pole	4	Article number	99 1528 814 04

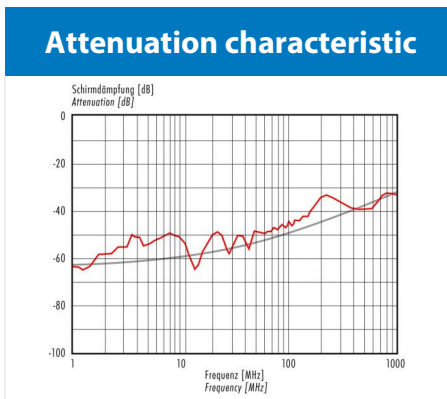
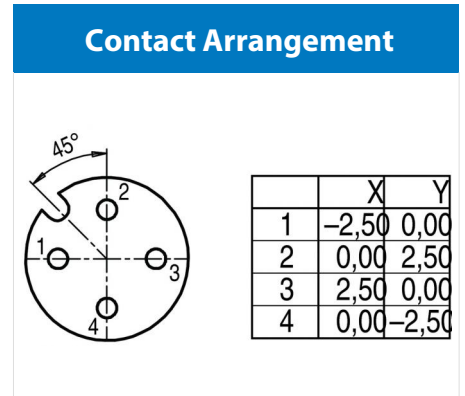
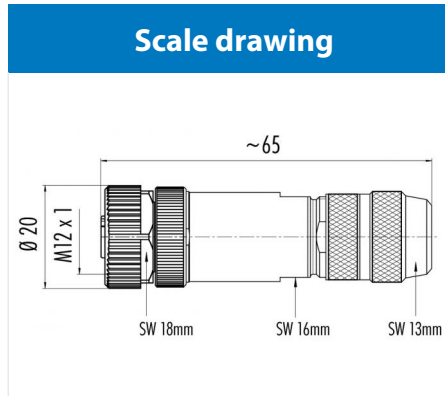

You can find the item description and assembly instruction on the next page.

Technical data

Common values

Connector Design	Female cable connector
Connector locking system	screw
Termination	Wire tension spring
Wire gauge (mm)	0.50 mm ²
Wire gauge (AWG)	20
Cable outlet	5 - 8 mm
Upper temperature	85 °C
Lower temperature	-40 °C

Electrical values

Rated voltage	250 V
Rated impulse voltage	2500 V
Pollution degree	3
Overvoltage category	II
Material group	III
Rated current (40°C)	4 A
Volume resistivity	≤ 3 mΩ
EMV compliance	not shielded
Degree of protection	IP67
Mechanical operation	> 100 mating cycles

Material

Material of contact	CuSn (Bronze)
Contact plating	Au (Gold)
Material of contact body	PA
Material of housing	Nickel-plated zinc die casting, PA

Contacts 4: cable outlet: 5-8 mm, female cable connector, shieldable, wire clamp connection, iris type spring, with die-cast threaded ring

Product	Contacts: 4, Female cable connector, shieldable, wire clamp connection, iris type spring	Area	M12-A Series 713
Pole	4	Article number	99 1528 814 04

Item description

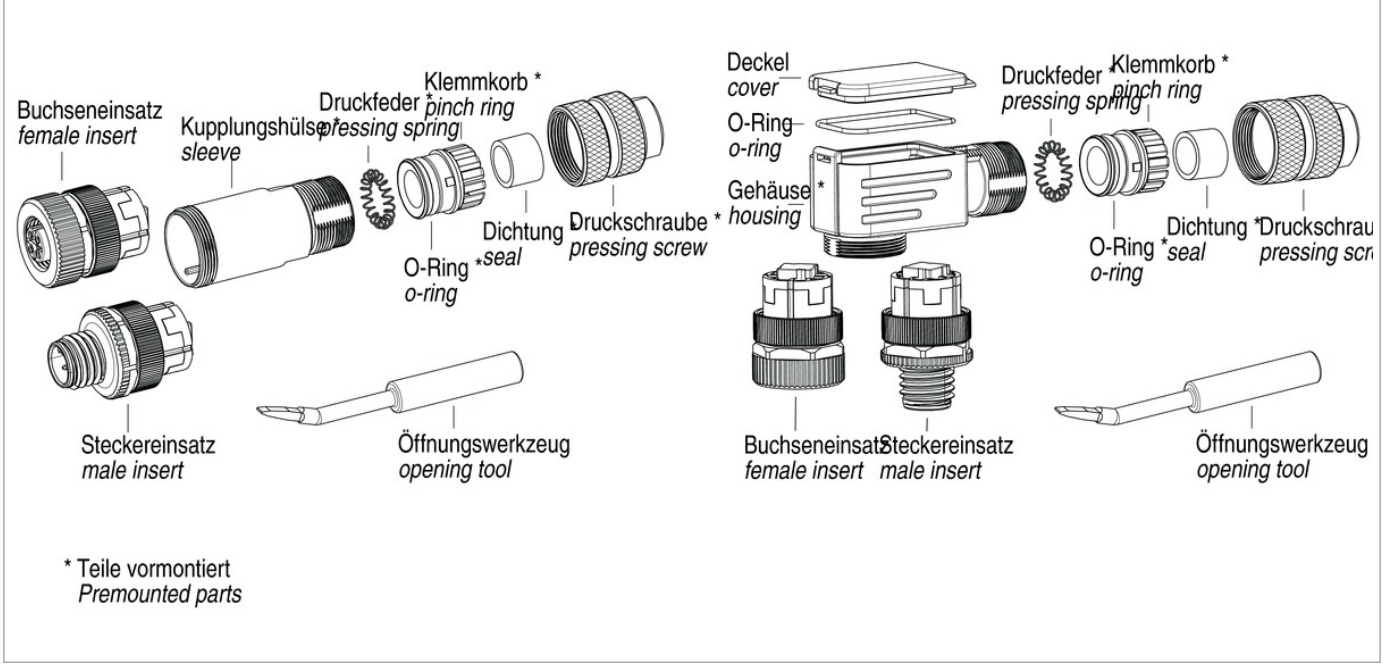

Installation instructions / Mounting cutout

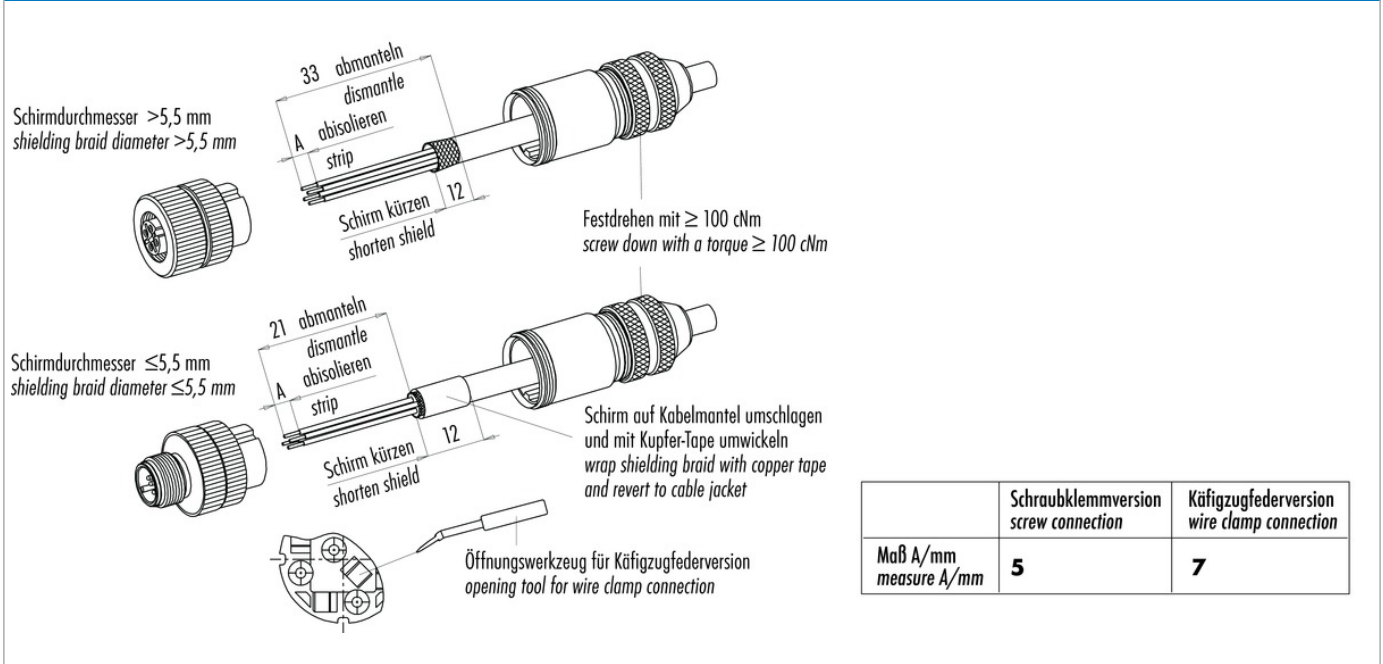

	Schraubklemmversion screw connection	Käfigzugfederversion wire clamp connection
Maß A/mm measure A/mm	5	7