

Product	<b>Contacts: 4, Male panel mount connector with single wires and UL approval, PG 11, PG 13.5, M20 x 1.5</b>	Area	<b>7/8" Series 820/870</b>
Pole	<b>4</b>	Article number	<b>09 2449 300 04</b>

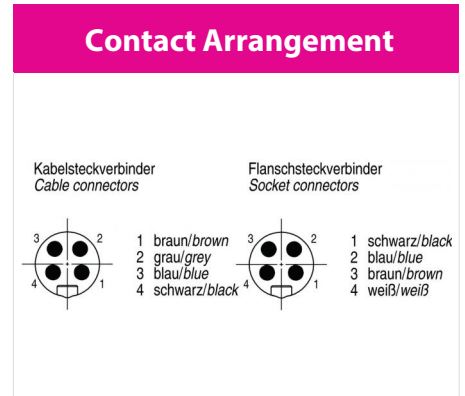
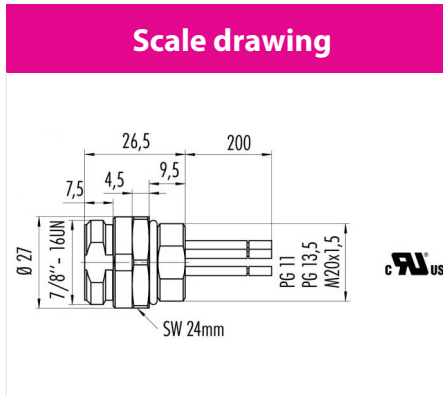
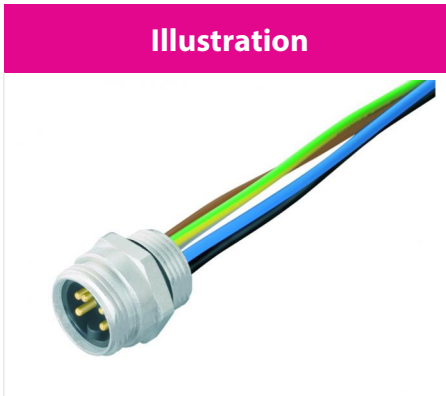

You can find the assembly instruction on the next page.

## Technical data

### Common values

Connector Design	Male panel mount connector
Connector locking system	Screws 7/8" - 16 UN
Termination	Litzen
Wire gauge (mm)	0.82 mm <sup>2</sup>
Wire gauge (AWG)	18
Upper temperature	85 °C
Lower temperature	-25 °C

### Cable data

material housing	-
Insulation single lead	-
Single lead structure	-
Conductor resistance	-
Bending radius cable fixed	-
Bending radius cable movable	-

### Electrical values

Rated voltage	250 V
Rated impulse voltage	4000 V
Pollution degree	3
Overvoltage category	III
Material group	III
Rated current (40°C)	8 A
Volume resistivity	≤ 3 mΩ
EMV compliance	-
Degree of protection	IP67
Mechanical operation	> 50 mating cycles

### Material

Material of contact	CuZn (Brass)
Contact plating	Au (Gold)
Material of contact body	PUR, PA (UL 94 HB)
Material of housing	Nickel-plated zinc die casting

fixing thread: PG 13.5, Contacts: 4, Male panel mount connector with single wires, with UL approval

Product	<b>Contacts: 4, Male panel mount connector with single wires and UL approval, PG 11, PG 13.5, M20 x 1.5</b>	Area	<b>7/8" Series 820/870</b>
Pole	<b>4</b>	Article number	<b>09 2449 300 04</b>

**Installation instructions / Mounting cutout**

Mit Durchgangsbohrung/With bore hole

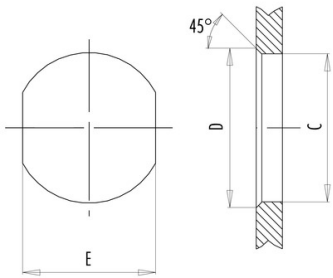

Mit Gewinde, einschraubbar/With thread to screw in

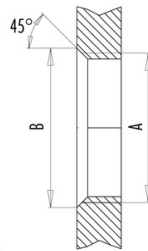

	A	B	C	D	E
PG11	PG11	20,2	18,7	20,2	17,0
PG13,5	PG13,5	22,0	20,5	22,0	18,8
M20x1,5	M20x1,5	21,6	20,1	21,6	17,8

alternativ/alternativ

Mit Durchgangsbohrung/With bore hole von vorn verschraubbar/front fastened

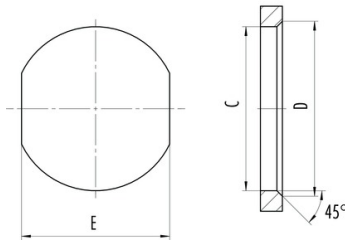

Mit Gewinde, einschraubbar/With thread to screw in

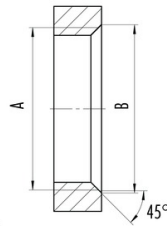

A	B	C	D	E
7/8-16UN-20	23	22,4	23,9	20,2
M26x1,5	27,3	26,2	27,7	24,2

alternativ/alternativ