

CS FAMILY SERIES / CSR·CSH·CS·TCS CONNECTOR

1.0mm pitch/Disconnectable Insulation displacement and Crimp style connectors

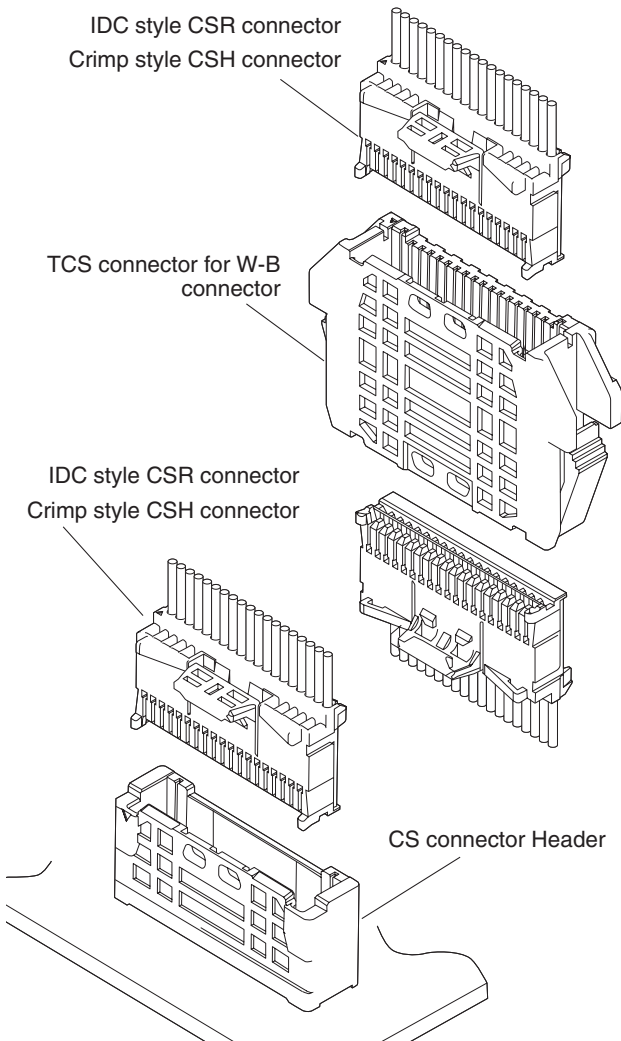

This is a 1.0mm pitch insulation displacement connector with the secure locking structure to prevent coming off the connector and incomplete mating. 1.8A in rated current was realized by using AWG#27. The various wide usage can be provided, since multi-IDC-harnesses by automatic IDC machine, crimping type, and header for wire to wire connection are available.

CS connector

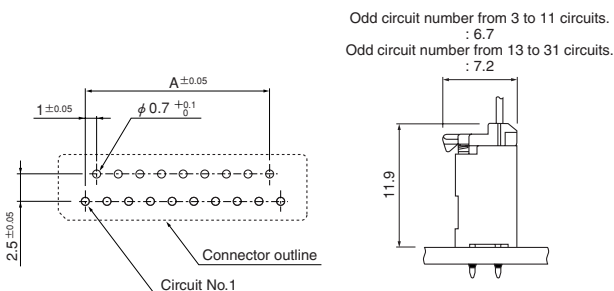

Note: 1. The above figure is the figure viewed from the connector mounting side.
 2. Tolerances are non-cumulative: $\pm 0.05\text{mm}$ for all centers.
 3. Hole dimensions differ according to the kind of PC board and piercing method. The dimensions above should serve as a guideline. Contact JST for details.

CS connector

- Secure locking structure
- Realization of multi-circuits by low insertion force
- Countermeasure for unexpected prying insertion

CSH connector

- Housing lances
- Interchangeability
- Realized current rating of 2A with AWG#26

TCS connector

- Secure locking structure
- Countermeasure for unexpected prying insertion

Standards

Recognized E60389

Certified LR20812

Specifications

	CSR · CS connector	CSH · CS connector	TCS connector
Current rating	1.8A(AWG#27)	2A(AWG #26)	
Voltage rating	50V AC · DC		
Temperature rise	-25°C to +85°C (including temperature rise)		
Contact resistance	Initial value / 15mΩ max. After environmental testing / 30mΩ max.	Initial value / 25mΩ max. After environmental testing / 50mΩ max.	
Insulation resistance	500MΩ min.		
Withstanding voltage	500V AC/minute		
Applicable wire	UL11079, UL3619, UL3855, UL11030 AWG#27·#28 Conductor / 7-strands, tinned annealed copper Insulation O.D. / 0.65 to 0.73mm (Contact JST for details.)	AWG#30 to #26 Insulation O.D. / 0.6 to 0.8mm	
Applicable PC board thickness	1.6mm	1.6mm	—
Applicable panel thickness	—	—	0.8 to 2.0mm

* Compliant with RoHS.

* Refer to "General Instruction and Notice when using Terminals and Connectors" at the end of this catalog.

* Contact JST for details.

TCS connector

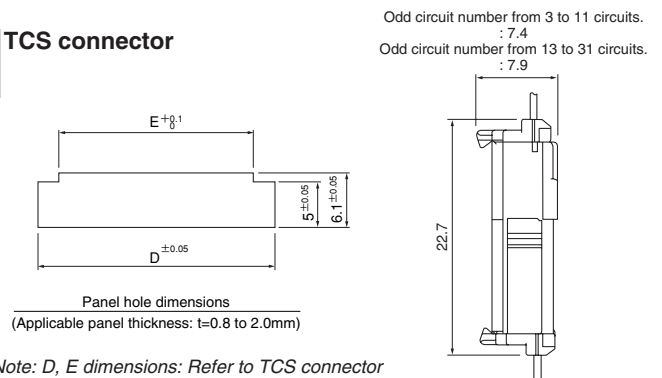

Note: D, E dimensions: Refer to TCS connector (Unit for wire-to-wire connection).

CS FAMILY SERIES / CSR·CSH·CS·TCS CONNECTOR

CSR connector socket

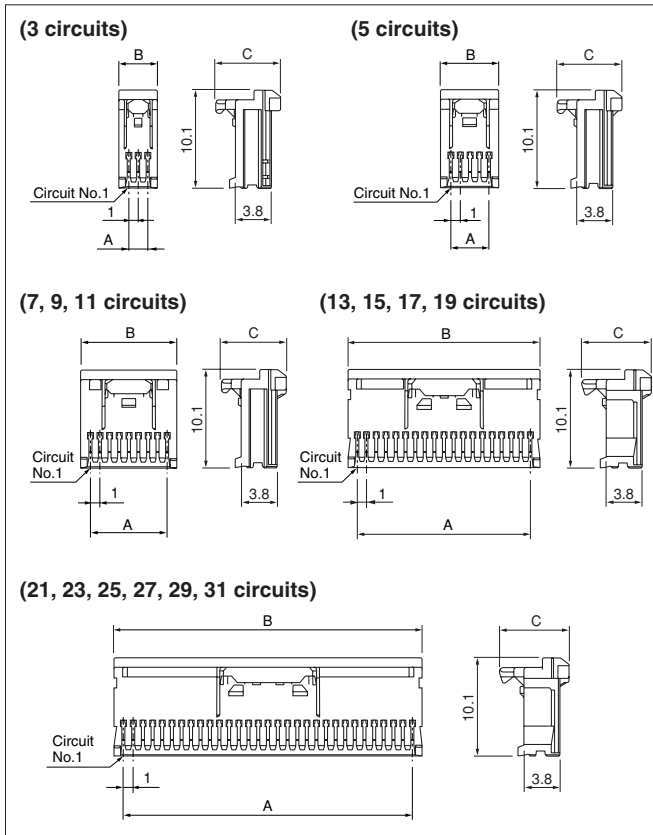

Circuits	Model No.	Dimensions (mm)			Q'ty / box
		A	B	C	
3	03CSR-8PK	2.0	4.0	6.7	13,500
5	05CSR-8PK	4.0	6.0		9,000
7	07CSR-8PK	6.0	8.0		6,660
9	09CSR-8PK	8.0	10.0		5,400
11	11CSR-8PK	10.0	12.0		4,500
13	13CSR-8PK	12.0	14.0		3,780
15	15CSR-8PK	14.0	16.0	7.2	3,240
17	17CSR-8PK	16.0	18.0		2,880
19	19CSR-8PK	18.0	20.0		2,700
21	21CSR-8PK	20.0	22.0		2,340
23	23CSR-8PK	22.0	24.0		2,160
25	25CSR-8PK	24.0	26.0		1,980
27	27CSR-8PK	26.0	28.0		1,800
29	29CSR-8PK	28.0	30.0		1,800
31	31CSR-8PK	30.0	32.0		1,620

Material and Finish

Contact: Copper alloy, tin-plated
Housing: PBT, UL94V-0, pink

RoHS compliance

CSH connector contact

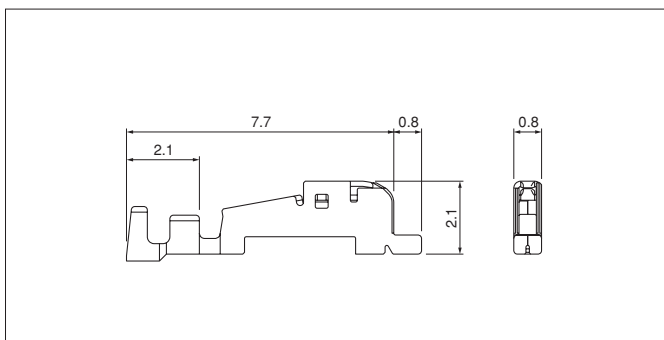

Model No.	Applicable wire		Insulation O.D. (mm)	Q'ty / reel
	mm ²	AWG#		
SCSH-002T-P0.2N	0.05 to 0.13	30 to 26	0.6 to 0.8	12,000

Material and Finish

Copper alloy, tin-plated

RoHS compliance

Contact	Crimping machine	Applicator		
		Crimp applicator	Dies	Crimp applicator with dies
SCSH-002T-P0.2N	AP-K2N	MKS-L-10-3	MK/SCSH-002-02	APLMK SCSH002-02
		—	—	—

CS FAMILY SERIES / CSR·CSH·CS·TCS CONNECTOR

CSH connector housing

(11 circuits)

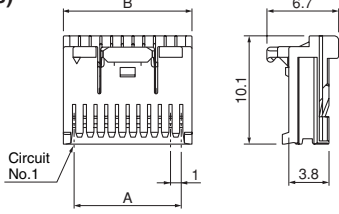

(13, 15, 17, 19 circuits)

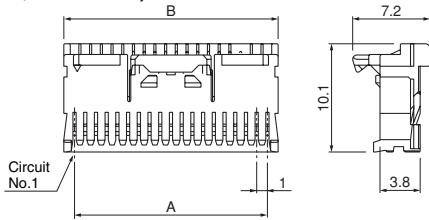

(25, 27 circuits)

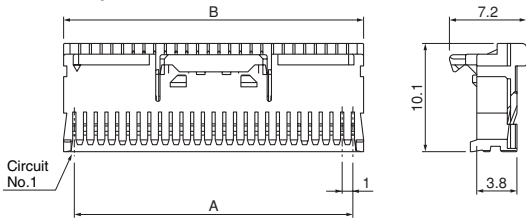

Circuits	Model No.	Dimensions (mm)		Q'ty / box
		A	B	
11	CSH-11-PK-N	10.0	12.0	1,000
13	CSH-13-PK-N	12.0	14.0	1,000
15	CSH-15-PK-N	14.0	16.0	1,000
17	CSH-17-PK-N	16.0	18.0	500
19	CSH-19-PK-N	18.0	20.0	500
25	CSH-25-PK-N	24.0	26.0	500
27	CSH-27-PK-N	26.0	28.0	500

Material

Housing: PBT, UL94V-0, pink

RoHS compliance

CS connector through-hole type shrouded header

(3 circuits)

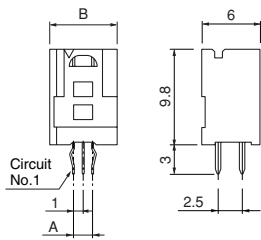

(5 circuits)

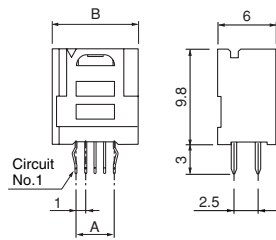

(7, 9, 11 circuits)

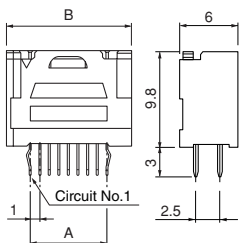

(13, 15, 17, 19 circuits)

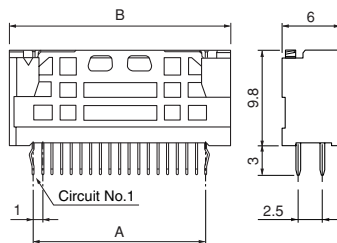

(21, 23, 25, 27, 29, 31 circuits)

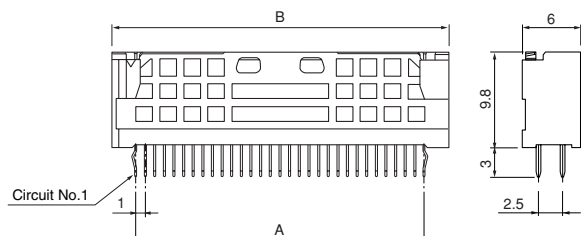

Circuits	Model No.	Dimensions (mm)		Q'ty / box
		A	B	
3	B03B-CSRK	2.0	7.0	10,800
5	B05B-CSRK	4.0	9.0	7,920
7	B07B-CSRK	6.0	11.0	6,480
9	B09B-CSRK	8.0	13.0	5,520
11	B11B-CSRK	10.0	15.0	4,800
13	B13B-CSRK	12.0	17.0	4,080
15	B15B-CSRK	14.0	19.0	3,600
17	B17B-CSRK	16.0	21.0	3,360
19	B19B-CSRK	18.0	23.0	3,120
21	B21B-CSRK	20.0	25.0	2,880
23	B23B-CSRK	22.0	27.0	2,640
25	B25B-CSRK	24.0	29.0	2,400
27	B27B-CSRK	26.0	31.0	2,160
29	B29B-CSRK	28.0	33.0	2,160
31	B31B-CSRK	30.0	35.0	1,920

Material and Finish

Housing: Glass-filled PA 66, UL94V-0, red

Contact: Copper alloy, copper-undercoated, tin-plated (reflow treatment)

RoHS compliance This product displays (LF)(SN) on a label.

CS FAMILY SERIES / CSR·CSH·CS·TCS CONNECTOR

TCS connector (Unit for wire-to-wire connection)

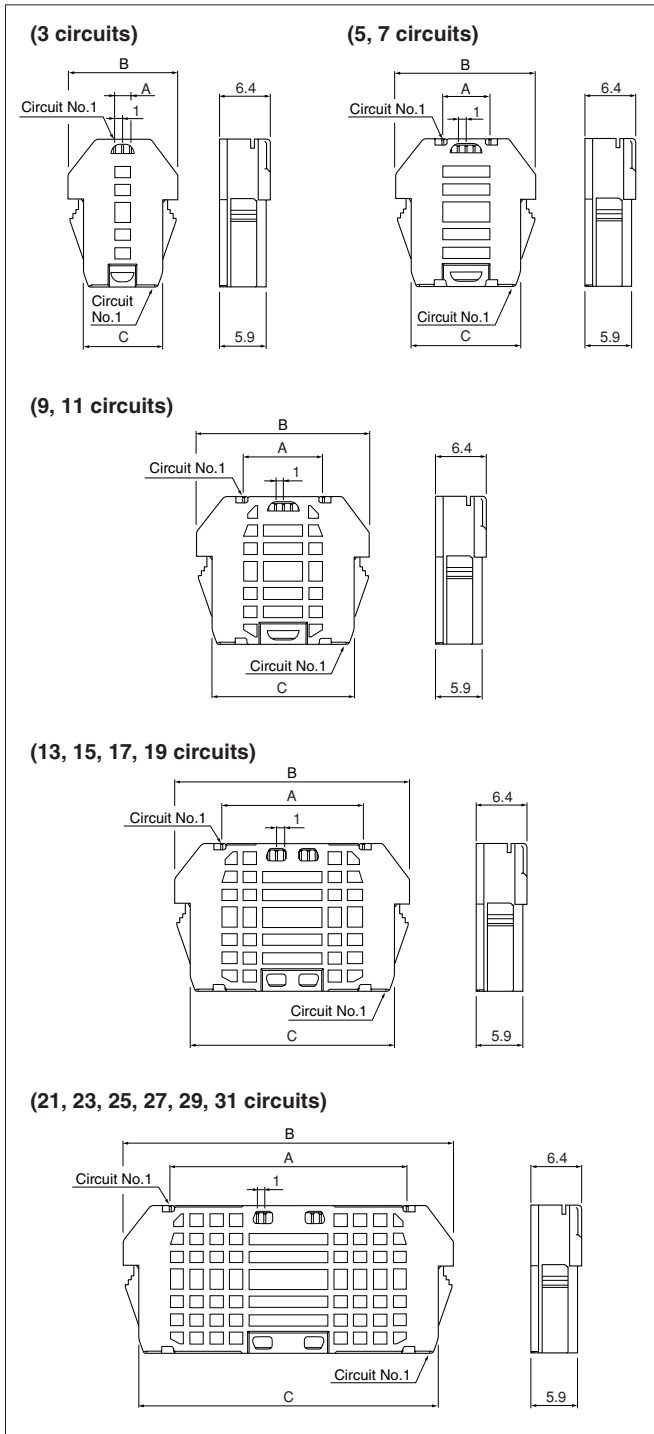

Circuits	Model No.	Dimensions (mm)					Q'ty / box	
		A	B	C	D			
					t0.8<D<t1.2	t1.2<D<t2.0	E	
3	BU03P-TCS-LE	2.0	13.8	10.0	10.7	11.0	6.2	300
5	BU05P-TCS-LE	4.0	15.8	12.0	12.7	13.0	8.2	250
7	BU07P-TCS-LE	6.0	17.8	14.0	14.7	15.0	10.2	250
9	BU09P-TCS-LE	8.0	19.8	16.0	16.7	17.0	12.2	250
11	BU11P-TCS-LE	10.0	21.8	18.0	18.7	19.0	14.2	200
13	BU13P-TCS-LE	12.0	23.8	20.0	20.7	21.0	16.2	200
15	BU15P-TCS-LE	14.0	25.8	22.0	22.7	23.0	18.2	150
17	BU17P-TCS-LE	16.0	27.8	24.0	24.7	25.0	20.2	150
19	BU19P-TCS-LE	18.0	29.8	26.0	26.7	27.0	22.2	150
21	BU21P-TCS-LE	20.0	31.8	28.0	28.7	29.0	24.2	100
23	BU23P-TCS-LE	22.0	33.8	30.0	30.7	31.0	26.2	100
25	BU25P-TCS-LE	24.0	35.8	32.0	32.7	33.0	28.2	100
27	BU27P-TCS-LE	26.0	37.8	34.0	34.7	35.0	30.2	100
29	BU29P-TCS-LE	28.0	39.8	36.0	36.7	37.0	32.2	100
31	BU31P-TCS-LE	30.0	41.8	38.0	38.7	39.0	34.2	100

Material and Finish

Housing: PBT, UL94V-0, light blue

Contact: Copper alloy, copper-undercoated, tin-plated (reflow treatment)

RoHS compliance This product displays (LF)(SN) on a label.