

Product sheet

Subminiature connector



Product Pole	Contacts 5, male panel mount connector 5	Area Article number	Snap-in IP67 Series 620 99 9215 00 05
--------------	--	---------------------	---

Illustration



Scale drawing

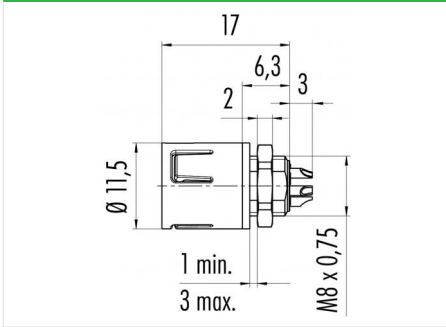

Contact Arrangement

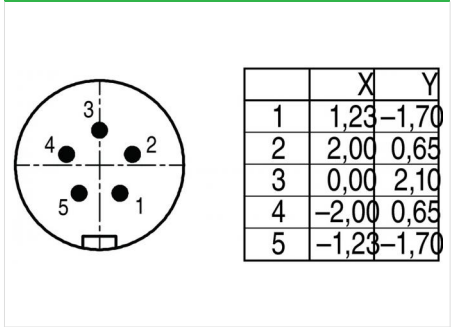

You can find the item description and assembly instruction on the next page.

Technical data

Common values

Connector Design	Male panel mount connector
Connector locking system	Snap
Termination	Solder
Wire gauge (mm)	0.25 mm ²
Wire gauge (AWG)	24
Cable outlet	3 - 5 mm
Upper temperature	85 °C
Lower temperature	-25 °C

Cable data

material housing	-
Insulation single lead	-
Single lead structure	-
Conductor resistance	-

Electrical values

Rated voltage	63 V
Rated impulse voltage	800 V
Pollution degree	2
Overvoltage category	II
Material group	II
Rated current (40°C)	2 A
Volume resistivity	≤ 3 mΩ
EMV compliance	not shieldable
Degree of protection	IP67
Mechanical operation	> 500 mating cycles

Material

Material of contact	CuZn (Brass)
Contact plating	Au (Gold)
Material of contact body	PA (UL 94 V-0)
Material of housing	PA (UL 94 V-0)

Contacts: 5, male panel mount connector

Product
Pole

Contacts 5, male panel mount connector
5

Area
Article number

Snap-in IP67 Series 620
99 9215 00 05

Item description

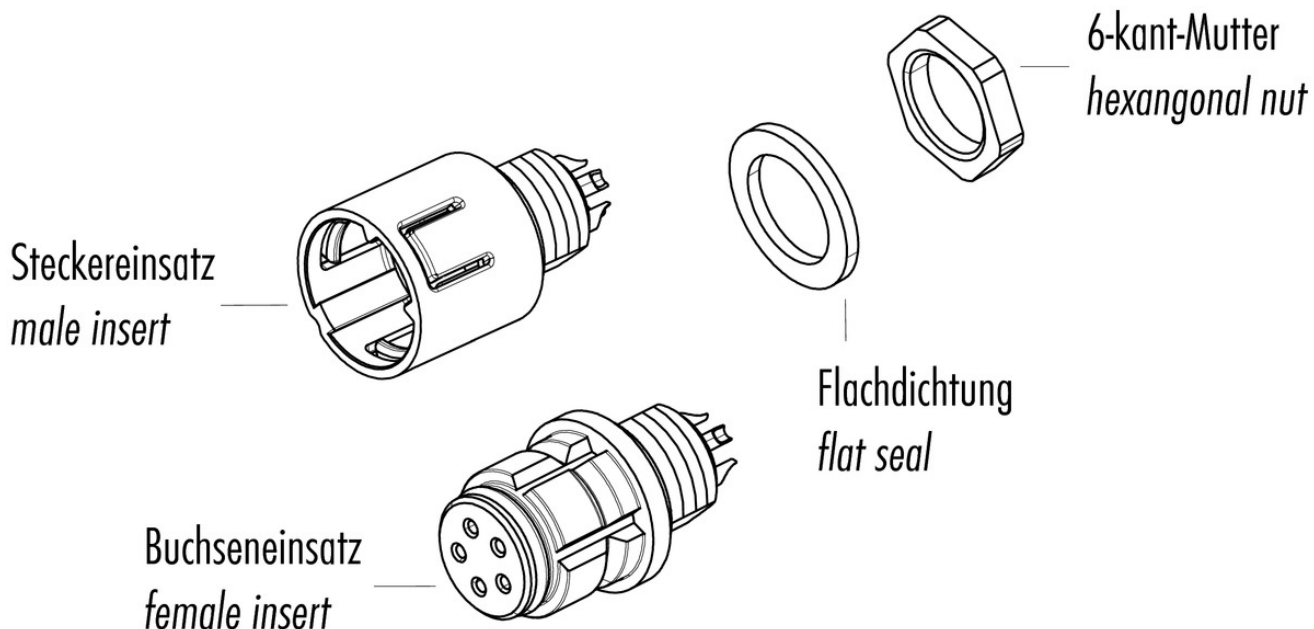

Installation instructions / Mounting cutout

