

Product sheet

Miniature connector



Product	Contacts: 3 DIN, female angled connector, cable outlet 4 - 6 mm	Area	M16 IP67 Series 723
Pole	3 DIN	Article number	99 0106 118 03

Illustration



Scale drawing

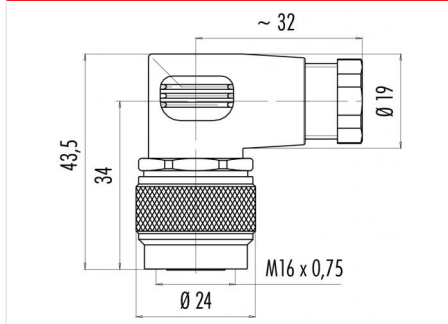

Contact Arrangement

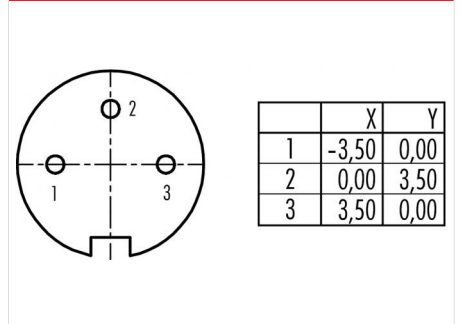

You can find the item description on the next page.

Technical data

Common values

Connector Design	Female angled connector
Connector locking system	screw
Termination	Solder
Wire gauge (mm)	0.75 mm ²
Wire gauge (AWG)	20
Cable outlet	4 - 6 mm
Upper temperature	95 °C
Lower temperature	-40 °C

Electrical values

Rated voltage	250 V
Rated impulse voltage	1500 V
Pollution degree	1
Overvoltage category	I
Material group	III
Rated current (40°C)	7 A
Volume resistivity	≤ 3 mΩ
EMV compliance	not shielded
Degree of protection	IP67
Mechanical operation	> 500 mating cycles

Material

Material of contact	CuSn (Bronze)
Contact plating	Au (Gold)
Material of contact body	PBT (UL 94 V-0)
Material of housing	PA (UL 94 HB)

Contacts: 3 DIN, Female angled connector, cable outlet 4 - 6 mm, gold plated contacts

Product	Contacts: 3 DIN, female angled connector, cable outlet 4 - 6 mm	Area	M16 IP67 Series 723
Pole	3 DIN	Article number	99 0106 118 03

Item description

