

Product	Contacts 5: Female cable connector, shieldable, wire clamp connection, static ring version	Area	M12-A Series 713
Pole	5	Article number	99 1538 814 05

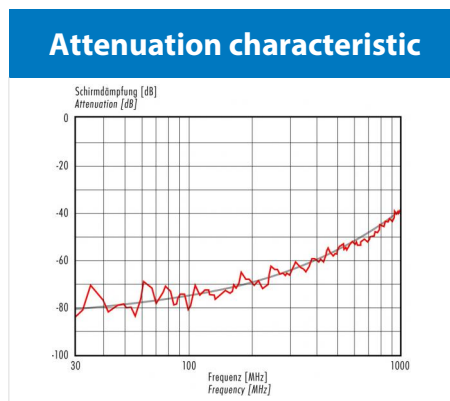
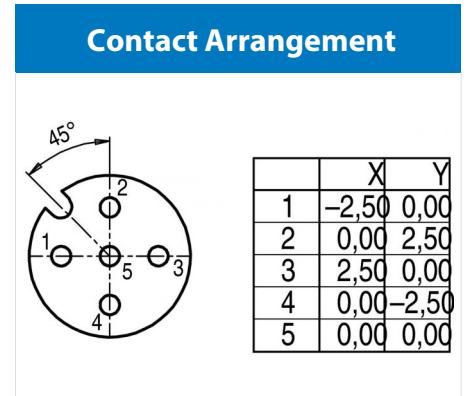
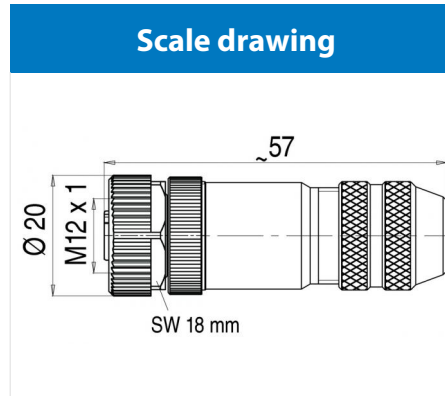

You can find the item description and assembly instruction on the next page.

Technical data

Common values

Connector Design	Female cable connector
Connector locking system	screw
Termination	Wire tension spring
Wire gauge (mm)	0.50 mm ²
Wire gauge (AWG)	20
Cable outlet	4 - 6 mm
Upper temperature	85 °C
Lower temperature	-40 °C

Electrical values

Rated voltage	125 V
Rated impulse voltage	1500 V
Pollution degree	3
Overvoltage category	II
Material group	III
Rated current (40°C)	4 A
Volume resistivity	≤ 3 mΩ
EMV compliance	shielded
Degree of protection	IP67
Mechanical operation	> 100 mating cycles

Material

Material of contact	CuSn (Bronze)
Contact plating	Au (Gold)
Material of contact body	PA
Material of housing	Nickel-plated zinc die casting, PA

Contacts 5: cable outlet: 4-6 mm, female cable connector, shieldable, wire clamp connection, static ring version, with die-cast threaded ring

Product	Contacts 5: Female cable connector, shieldable, wire clamp connection, static ring version	Area	M12-A Series 713
Pole	5	Article number	99 1538 814 05

Item description

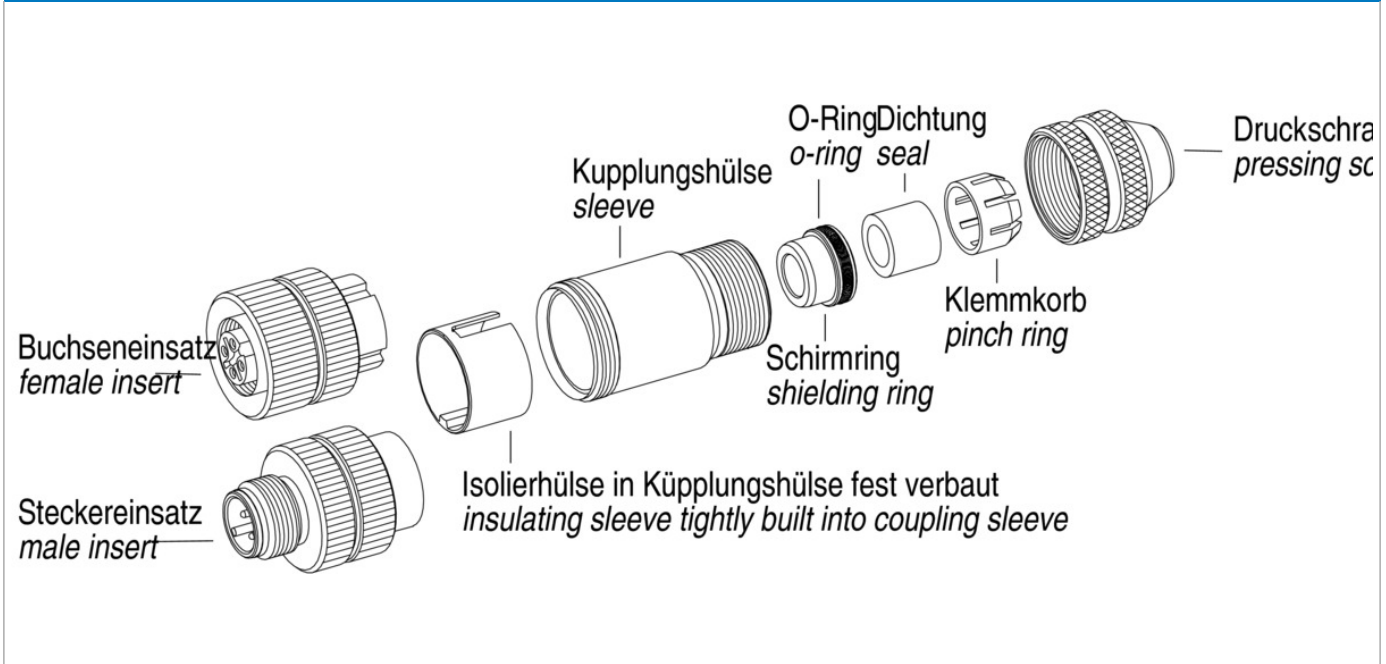

Installation instructions / Mounting cutout

