

Product	Polzahl: 8, Winkelstecker umspritzt, geschirmt	Area	M12-A Series 763
Pole	8	Article number	77 3527 0000 20708-0200

Illustration

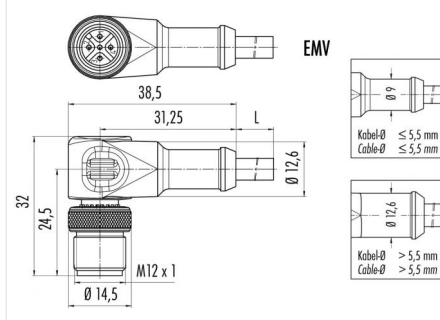

Scale drawing



Technical data

Common values

Connector locking system	screw
Termination	crimp, injection-moulded cable
Wire gauge (mm)	0.25 mm ²
Wire gauge (AWG)	24
Upper temperature	85 °C
Lower temperature	-25 °C

Cable data

material housing	PVC
Insulation single lead	PVC
Single lead structure	14 x 0.16
Cable sheath Ø	5.3
Conductor resistance	75.5Ω/Km
Temperature range cable movable c from	-5
Temperature range cable movable c to	70
Temperature range cable fixed c from	-25
Temperature range cable fixed c to	70
Bending radius cable fixed	60 mm
Bending radius cable movable	120 mm

Electrical values

Pollution degree	3
Overvoltage category	II
Material group	II
Rated current (40°C)	4 A
Volume resistivity	≤ 3 mΩ
EMV compliance	geschirmt
Degree of protection	IP67
Mechanical operation	> 100 mating cycles

Material

Material of contact	CuZn (Brass)
Contact plating	Au (Gold)
Material of contact body	PUR
Material of housing	PUR

Polzahl: 8, Kabellänge 2 m, Kabel: 8 x 0,25 mm², PVC, Winkelstecker umspritzt, geschirmt