

Product	Contacts: 4, Cable plug connector, shieldable, screw terminal connection, static ring version, with UL approval	Area	M12-A Series 713
Pole	4	Article number	99 1429 812 04

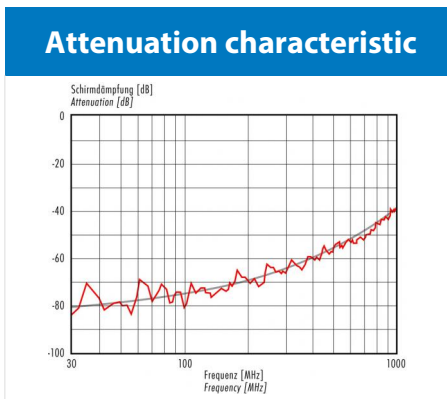
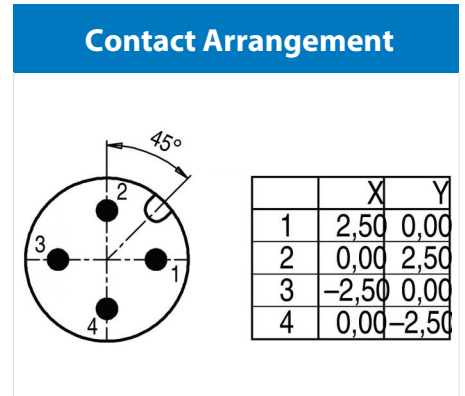
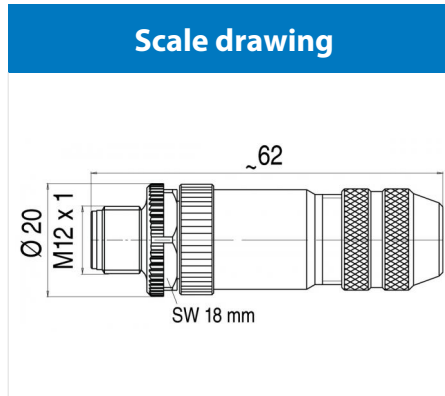

You can find the item description and assembly instruction on the next page.

Technical data

Common values

Connector Design	Cable plug connector
Connector locking system	screw
Termination	Screwing
Wire gauge (mm)	0.75 mm ²
Wire gauge (AWG)	18
Cable outlet	6 - 8 mm
Upper temperature	85 °C
Lower temperature	-40 °C

Electrical values

Rated voltage	250 V
Rated impulse voltage	2500 V
Pollution degree	3
Overtoltage category	II
Material group	II
Rated current (40°C)	4 A
Volume resistivity	≤ 3 mΩ
EMV compliance	geschirmt
Degree of protection	IP67
Mechanical operation	> 100 mating cycles

Material

Material of contact	CuZn (Brass)
Contact plating	Au (Gold)
Material of contact body	PA
Material of housing	Nickel-plated zinc die casting

Contacts: 4, Cable outlet: 6-8 mm, cable plug connector, shieldable, screw terminal connection, static ring version with die-cast threaded ring, with UL approval

Product	Contacts: 4, Cable plug connector, shieldable, screw terminal connection, static ring version, with UL approval	Area	M12-A Series 713
Pole	4	Article number	99 1429 812 04

Item description

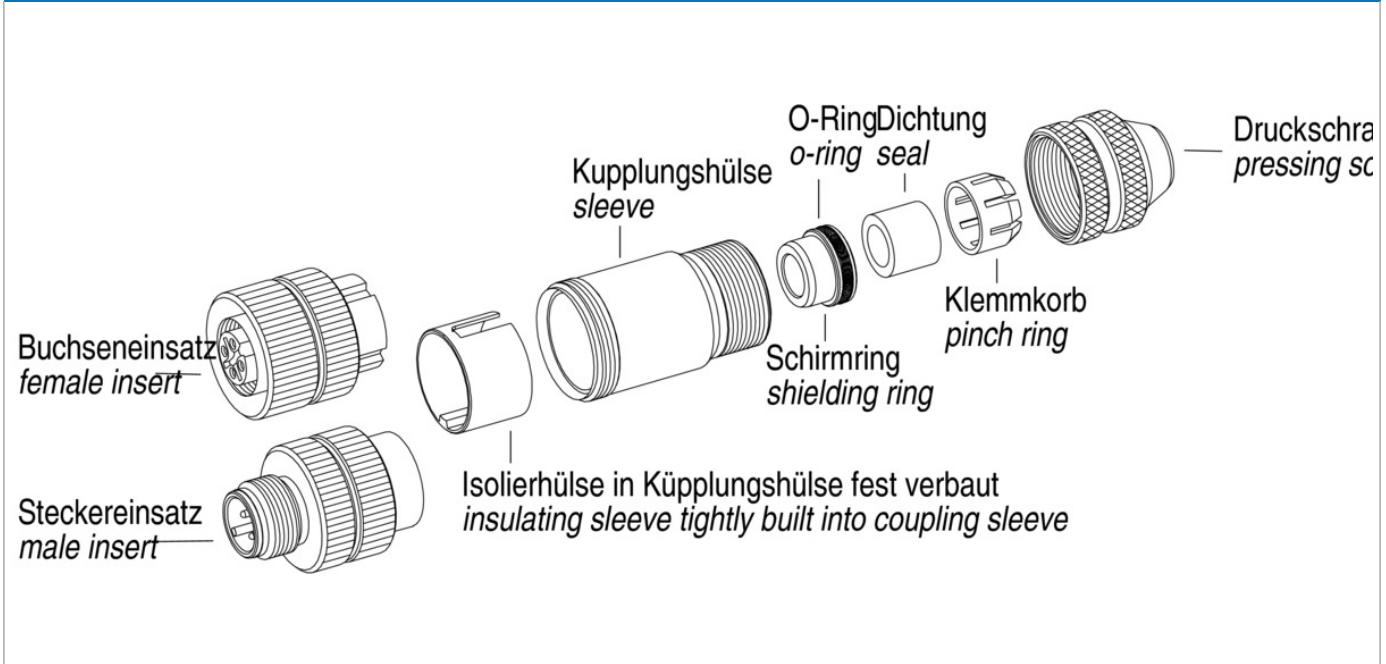

Installation instructions / Mounting cutout

