

Product	Contacts 4: Cable plug connector, shieldable, wire clamp connection, static ring version	Area	M12-A Series 713
Pole	4	Article number	99 1525 814 04

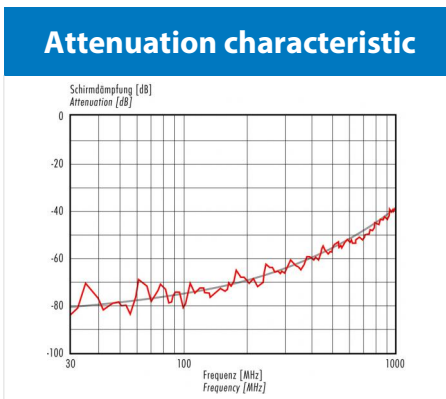
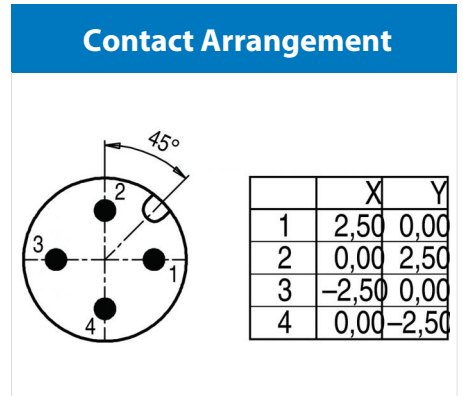
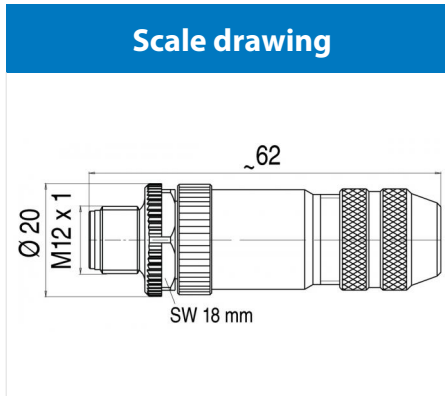

You can find the item description and assembly instruction on the next page.

Technical data

Common values

Connector Design	Cable plug connector
Connector locking system	screw
Termination	Wire tension spring
Wire gauge (mm)	0.50 mm ²
Wire gauge (AWG)	20
Cable outlet	4 - 6 mm
Upper temperature	85 °C
Lower temperature	-40 °C

Electrical values

Rated voltage	250 V
Rated impulse voltage	2500 V
Pollution degree	3
Overvoltage category	II
Material group	III
Rated current (40°C)	4 A
Volume resistivity	≤ 3 mΩ
EMV compliance	geschirmt
Degree of protection	IP67
Mechanical operation	> 100 mating cycles

Material

Material of contact	CuSn (Bronze)
Contact plating	Au (Gold)
Material of contact body	PA
Material of housing	Nickel-plated zinc die casting

Contacts 4: cable outlet: 4-6 mm, cable plug connector, shieldable, wire clamp connection, static ring version, with die-cast threaded ring

Product	Contacts 4: Cable plug connector, shieldable, wire clamp connection, static ring version	Area	M12-A Series 713
Pole	4	Article number	99 1525 814 04

Item description

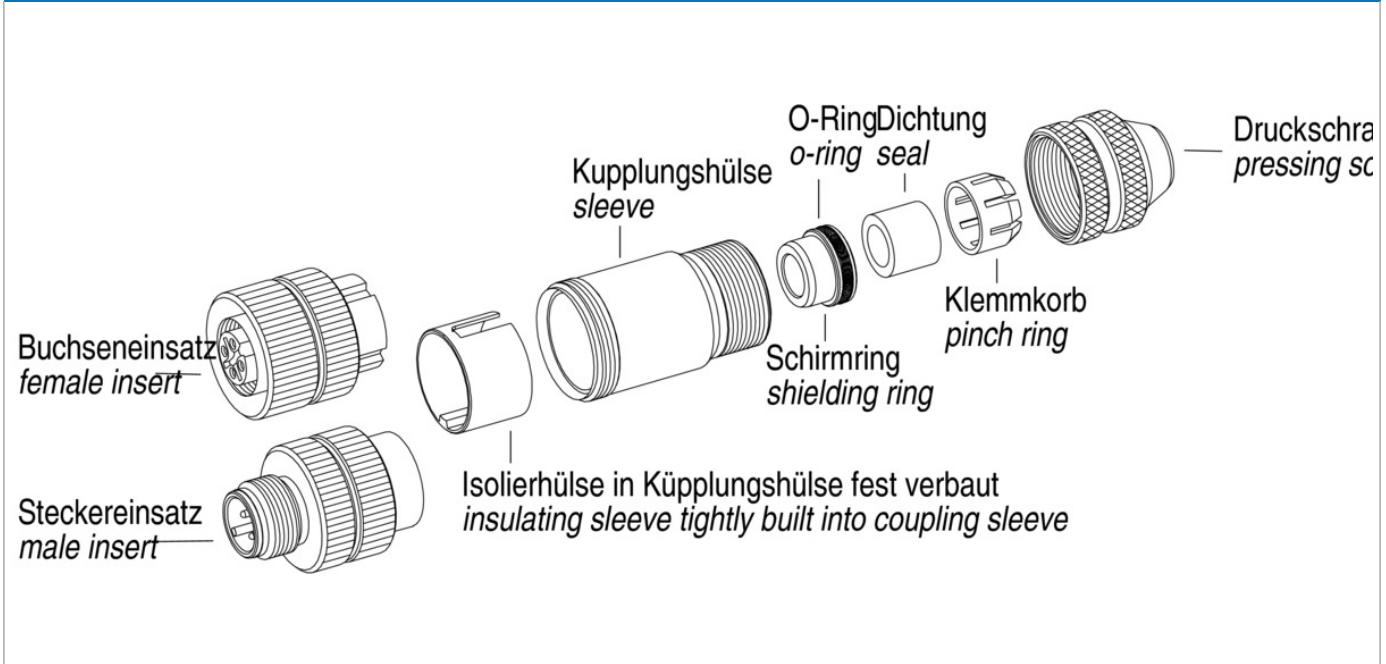

Installation instructions / Mounting cutout

