

FAZ CONNECTOR

Connectors for FFC

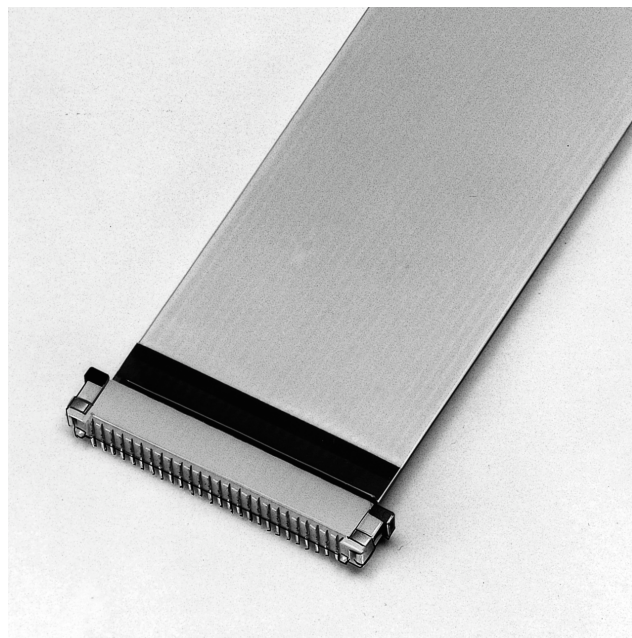

The FAZ series Zero Insertion Force (ZIF) connector has been developed as an SMT version of the existing FMZ connector.

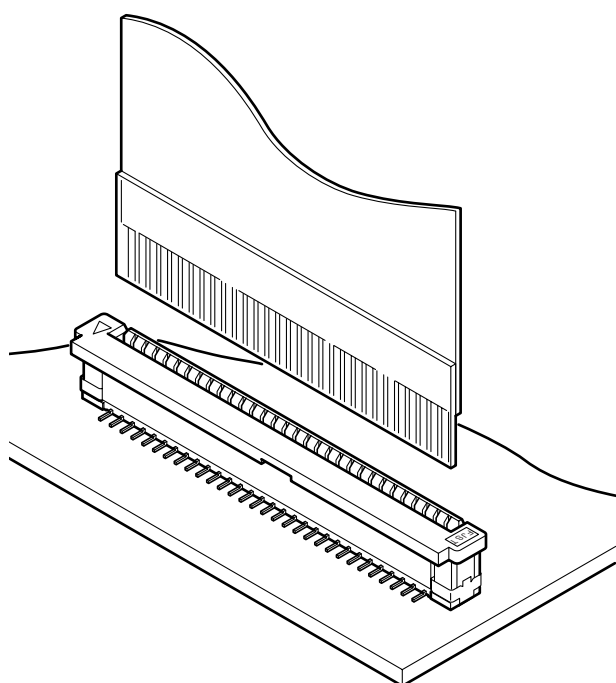

Features

• Zero insertion force mechanism (ZIF)

A ZIF mechanism improves wear resistance and extends the mating life of the connector. By moving the slider into its locking position after the FFC has been inserted into the connector, the FFC leads are securely locked in place.

• SMT configuration

Due to its small pitch and its ability to be surface mounted, this connector meets today's demand for high-density packaging. Top entry and side entry versions are available. Top entry is available with either an in-line or a staggered solder tail footprint whilst the side entry version is available with FFC contact points on either the upper or lower sides.

• Embossed taping for automatic mounting

This connector is supplied in embossed tape packaging, for mounting by automatic placement machines.

Specifications

- Current rating: 1.0A , AC, DC
- Voltage rating: 50V AC, DC
- Temperature range: -25°C to +85°C
(including temperature rise in applying electrical current)
- Contact resistance: Initial value/20m Ω max.
After environmental testing/40m Ω max.
- Insulation resistance: 500M Ω min.
- Withstanding voltage: 500V AC/minute
- Applicable FFC: Conductor pitch/1.0mm
Conductor width/0.7mm
Mating part thickness/0.30±0.05mm

<Note>FFC to be actually used should be checked for applicability.

- * Compliant with RoHS.
- * Refer to "General Instruction and Notice when using Terminals and Connectors" at the end of this catalog.
- * Contact JST for details.

Standards

Recognized E60389

Certified LR20812

Connector

Top entry type <In-line, Normal type>

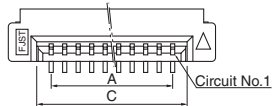

With bosses

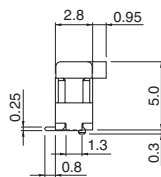
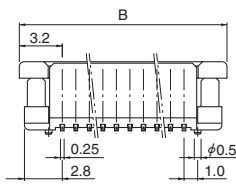

Without bosses

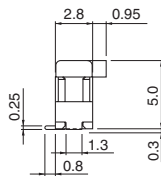
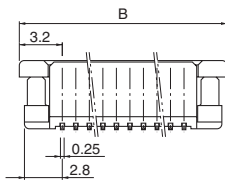

<In-line, Reverse type>

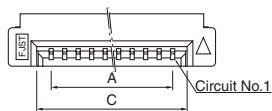

With bosses

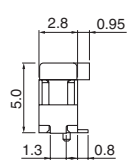
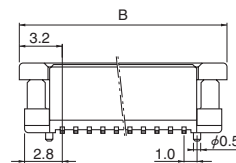

Without bosses

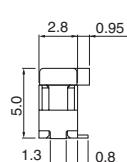
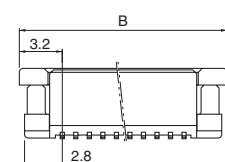

<Staggered, Normal type>

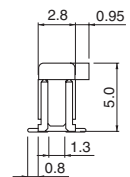
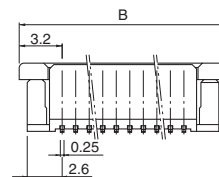
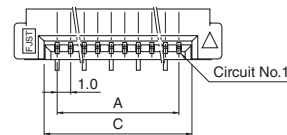

<Staggered, Large slider type>

With solder tab

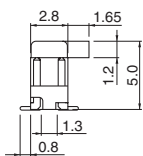
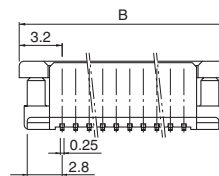
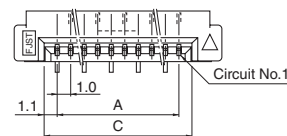

Without solder tab

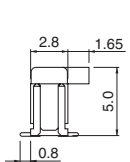
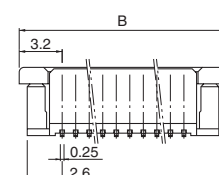
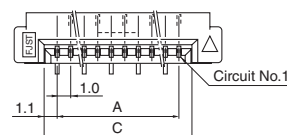

FAZ CONNECTOR

Side entry type

<In-line, Normal type>

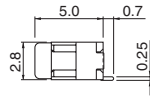
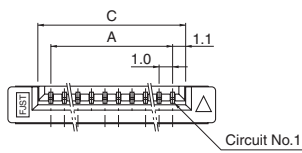
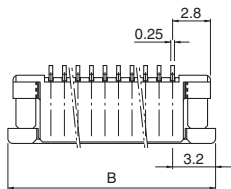

<In-line, Reverse type>

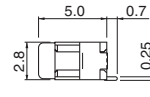
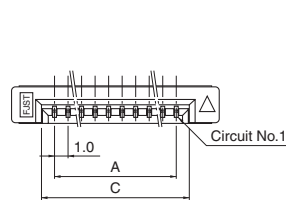
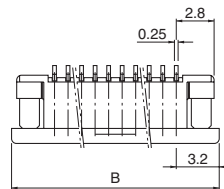

Circuits	Model No.									Dimensions (mm)			Q'ty / reel	
	Top entry type				Side entry type					A	B	C	Top entry type	Side entry type
	In-line		Staggered		In-line		Normal type	Reverse type						
	Normal type	Reverse type	Normal type	Large slider type	Normal type	Reverse type								
With bosses	Without bosses	With bosses	Without bosses	Normal type	With solder tab	Without solder tab	Normal type	Reverse type						
8	-	-	-	-	-	-	-	S08FAZ-SM-TB	S08FAZ-RSM-TB	7.0	13.4	9.2	-	2,000
9	-	-	-	-	T09FAZ-SMT-TF	-	-	S09FAZ-SM-TB	-	8.0	14.4	10.2	1,000	2,000
11	-	-	-	-	-	-	-	S11FAZ-SM-TB	S11FAZ-RSM-TB	10.0	16.4	12.2	-	2,000
16	-	-	-	-	-	-	-	S16FAZ-SM-TB	S16FAZ-RSM-TB	15.0	21.4	17.2	-	2,000
20	-	-	-	-	T20FAZ-SMT-TF	-	-	S20FAZ-SM-TB	S20FAZ-RSM-TB	19.0	25.4	21.2	1,000	2,000
22	-	-	-	-	T22FAZ-SMT-TF	T22FAZ-SMT-F-TF	T22FAZ-SMT-NF-TF	-	S22FAZ-RSM-TB	21.0	27.4	23.2	1,000	2,000
24	-	-	-	-	T24FAZ-SMT-TF	-	-	-	-	23.0	29.4	25.2	1,000	-
25	-	-	-	-	-	-	-	S25FAZ-SM-TB	-	24.0	30.4	26.2	-	2,000
26	T26FAZ-SM-1-TB	T26FAZ-SM-TB	T26FAZ-RSM-1-TF	T26FAZ-RSM-TF	T26FAZ-SMT-TF	T26FAZ-SMT-F-TF	T26FAZ-SMT-NF-TF	S26FAZ-SM-TB	S26FAZ-RSM-TB	25.0	31.4	27.2	1,000	2,000

Material and Finish

Contact: Phosphor bronze, copper-undercoated, tin-plated (reflow treatment)
 Receptacle housing: PA 6T, UL94V-0, ivory (natural)
 Slider housing: PPS, UL94V-0, brown (natural)
 Solder tab: Phosphor bronze, copper-undercoated, tin-plated (reflow treatment)

RoHS compliance This product displays (LF)(SN) on a label.
 Note: The products listed above are supplied on embossed tape.

Lead section dimensions of FFC

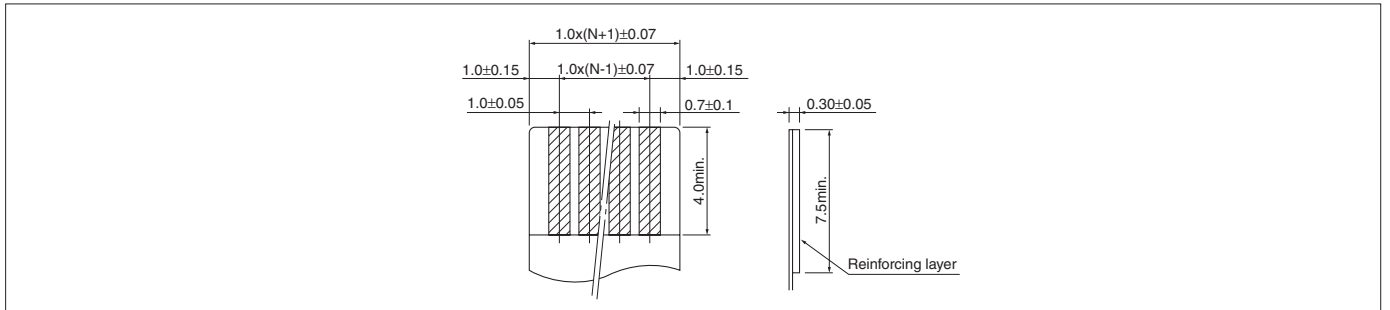

Note: N --- Number of circuits

PC board layout (viewed from component side)

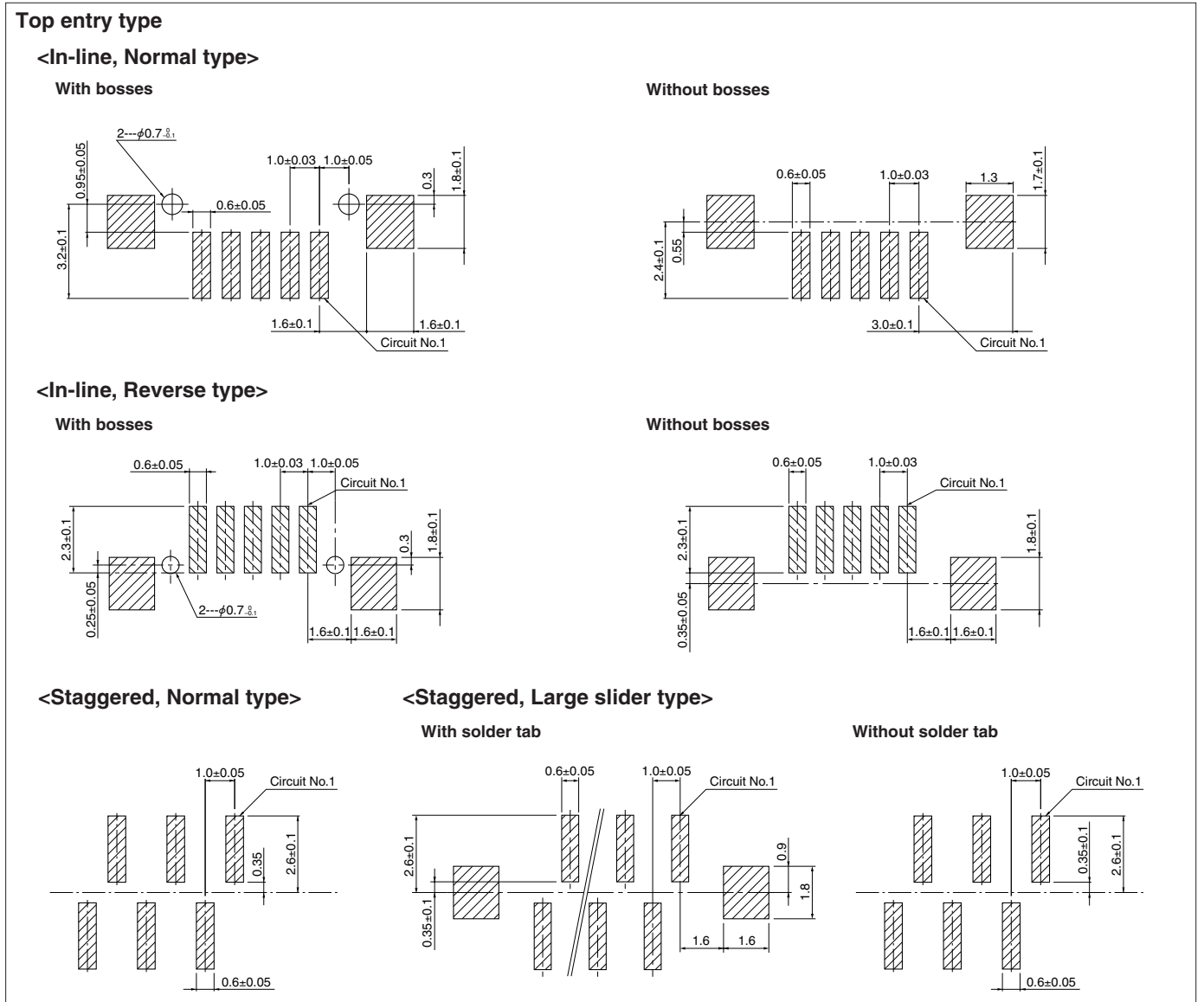

Note:

1. Tolerances are non-cumulative: $\pm 0.03 \text{ mm}$ for all centers.
2. The dimensions above should serve as a guideline. Contact JST for details.

FAZ CONNECTOR

PC board layout (viewed from component side)

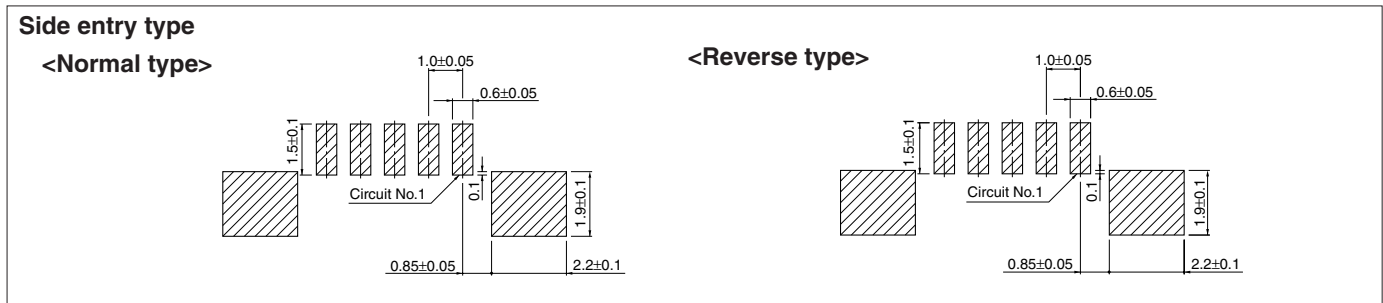

Note:

1. Tolerances are non-cumulative: $\pm 0.05\text{mm}$ for all centers.
2. The dimensions above should serve as a guideline. Contact JST for details.

Assembly layout

