

Product sheet
Miniature connector



Product	Polzahl: 12, Flanschstecker, tauchlöten, von vorn verschraubbar, mit Schirmanbindung	Area	M16 IP67 Series 423/ 723/ 425
Pole	12	Article number	09 0131 290 12

Illustration



Conductor layout

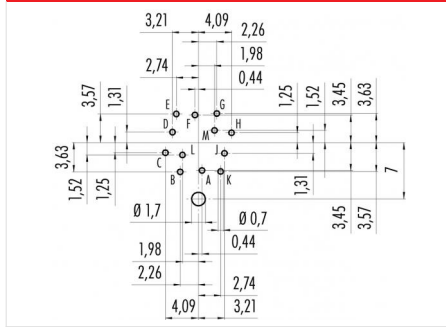

Scale drawing

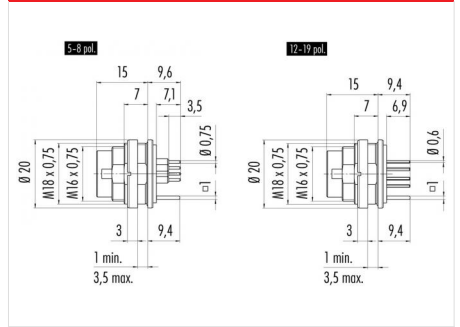

Technical data

Common values

Connector Design	Male panel mount connector
Connector locking system	screw
Wire gauge (mm)	-
Wire gauge (AWG)	-
Upper temperature	95 °C
Lower temperature	-40 °C

Electrical values

Rated voltage	60 V
Rated impulse voltage	500 V
Pollution degree	1
Overvoltage category	I
Material group	III
Rated current (40°C)	3 A
Volume resistivity	≤ 3 mΩ
Degree of protection	IP67
Mechanical operation	> 500 mating cycles

Material

Material of contact	CuZn (Brass)
Contact plating	Au (Gold)
Material of contact body	PBT (UL 94 V-0)
Material of housing	Nickel-plated zinc die casting, nickel-plated brass

Polzahl: 12, Flanschstecker, tauchlöten, von vorn verschraubbar, vergoldete Kontakte, mit Schirmanbindung