

Product sheet

Subminiature connector



Product	Contacts: 5, female angled connector overmoulded, unshielded	Area	M9 IP67 Series 702
Pole	5	Article number	79 1456 272 05

Illustration



Scale drawing

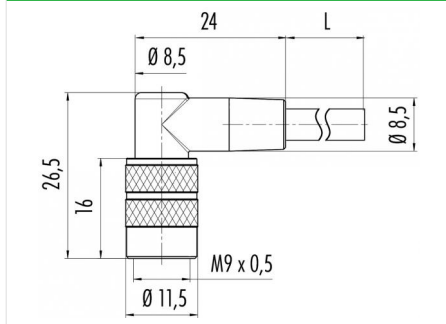

Contact Arrangement

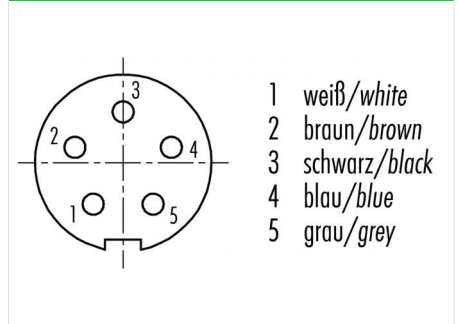

Technical data

Common values

Connector Design	Female angled connector
Connector locking system	screw
Termination	overmoulded on cable
Wire gauge (mm)	0.25 mm ²
Wire gauge (AWG)	24
Cable outlet	-
Upper temperature	70 °C
Lower temperature	-25 °C

Electrical values

Rated voltage	125 V
Rated impulse voltage	1500 V
Pollution degree	1
Overvoltage category	II
Material group	III
Rated current (40°C)	3 A
Volume resistivity	≤ 3 mΩ
EMV compliance	nicht geschirmt
Degree of protection	IP67
Mechanical operation	> 500 mating cycles

Cable data

material housing	PUR
Insulation single lead	PVC
Single lead structure	32 x 0.1 mm
Cable sheath Ø	5
Conductor resistance	72Ω/Km
Temperature range cable movable c from	-5
Temperature range cable movable c to	70
Temperature range cable fixed c from	-25
Temperature range cable fixed c to	70
Bending radius cable fixed	Min. 25 mm
Bending radius cable movable	Min. 50 mm

Material

Material of contact	CuSn (Bronze)
Contact plating	Au (Gold)
Material of contact body	PBT (UL 94 V-0)
Material of housing	PUR

Contacts: 5, female angled connector overmoulded, unshielded, cable length 2 m