

# Product sheet

## Miniature connector



Product	<b>Contacts: 5, female panel mount connector, red</b>	Area	<b>Snap-in IP67 Series 720</b>
Pole	<b>5</b>	Article number	<b>99 9116 50 05</b>

### Illustration



### Scale drawing

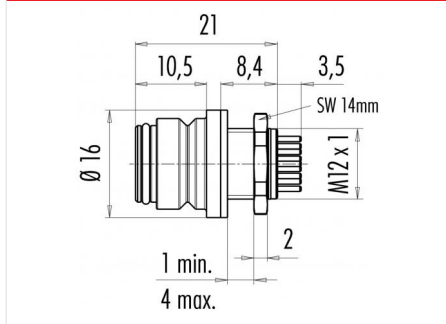

### Contact Arrangement

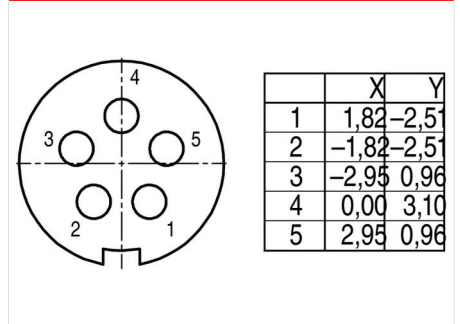

You can find the item description and assembly instruction on the next page.

## Technical data

### Common values

Connector Design	Female panel mount connector
Connector locking system	Snap
Termination	Solder
Wire gauge (mm)	0.75 mm <sup>2</sup>
Wire gauge (AWG)	20
Cable outlet	-
Upper temperature	85 °C
Lower temperature	-25 °C

### Electrical values

Rated voltage	125 V
Rated impulse voltage	1500 V
Pollution degree	2
Overvoltage category	II
Material group	II
Rated current (40°C)	5 A
Volume resistivity	≤ 3 mΩ
EMV compliance	not shielded
Degree of protection	IP67
Mechanical operation	> 500 mating cycles

### Material

Material of contact	CuSn (Bronze)
Contact plating	Au (Gold)
Material of contact body	PA (UL 94 V-0)
Material of housing	PA (UL 94 V-0)

Contacts: 5, female panel mount connector, red

Product	<b>Contacts: 5, female panel mount connector, red</b>	Area	<b>Snap-in IP67 Series 720</b>
Pole	<b>5</b>	Article number	<b>99 9116 50 05</b>

Item description

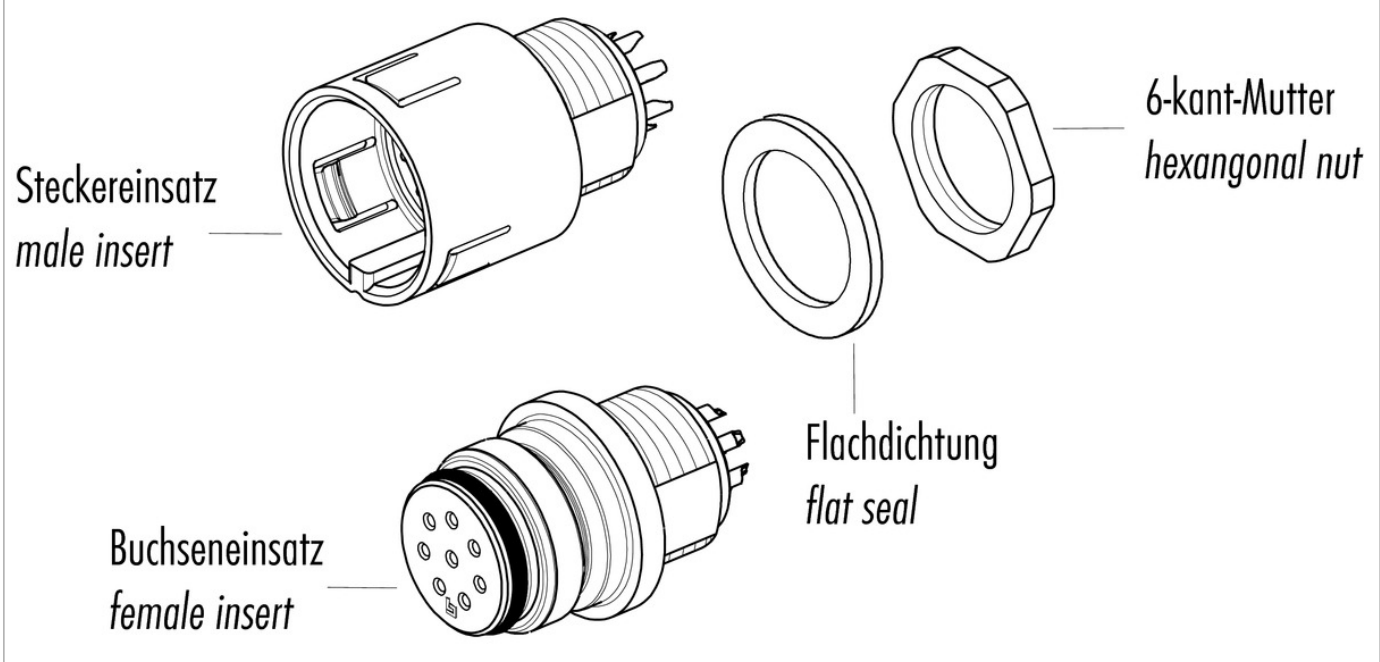

Installation instructions / Mounting cutout

