

Product sheet
Miniature connector



Product Pole	Contacts: 7, male panel mount connector 7	Area Article number	Bayonet IP40 Series 678 99 0623 00 07
--------------	---	---------------------	---

Illustration



Scale drawing

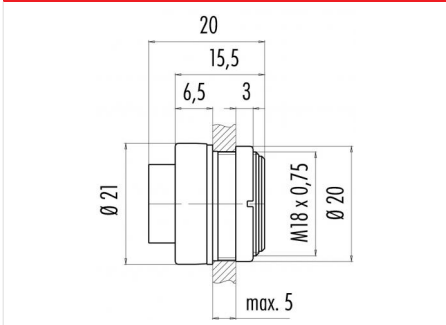

Contact Arrangement

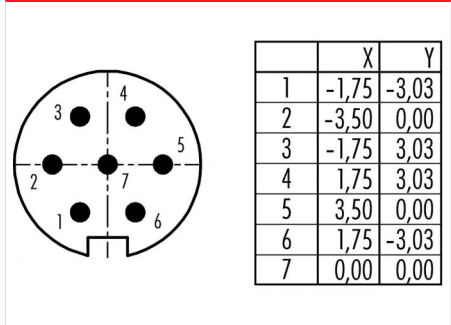

You can find the assembly instruction on the next page.

Technical data

Common values

Connector Design	Male panel mount connector
Connector locking system	Bayonet
Termination	Solder
Wire gauge (mm)	0.75 mm ²
Wire gauge (AWG)	20
Cable outlet	-
Upper temperature	85 °C
Lower temperature	-40 °C

Electrical values

Rated voltage	125 V
Rated impulse voltage	800 V
Pollution degree	1
Overvoltage category	I
Material group	III
Rated current (40°C)	5 A
Volume resistivity	≤ 5 mΩ
EMV compliance	not shielded
Degree of protection	IP40
Mechanical operation	> 500 mating cycles

Material

Material of contact	CuZn (Brass)
Contact plating	Ag (Silver)
Material of contact body	PBT (UL 94 V-0)
Material of housing	PA (UL 94 V-0)

Contacts: 7, male panel mount connector

Product
Pole

Contacts: 7, male panel mount connector
7

Area
Article number

Bayonet IP40 Series 678
99 0623 00 07

Installation instructions / Mounting cutout

