

Product	<b>Contacts: 4, Female cable connector, plastic lock, screw terminal connection, with UL approval</b>	Area	<b>M12-B Series 715</b>
Pole	<b>4</b>	Article number	<b>99 0430 15 04</b>

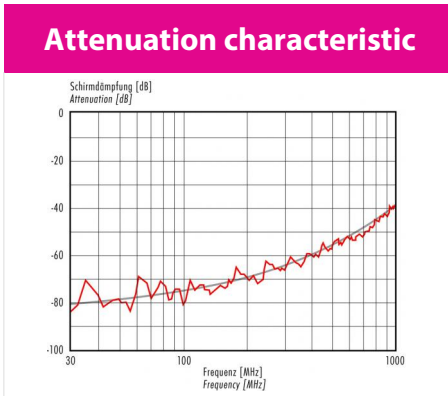
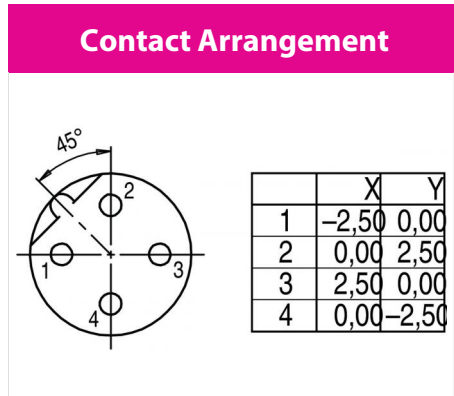
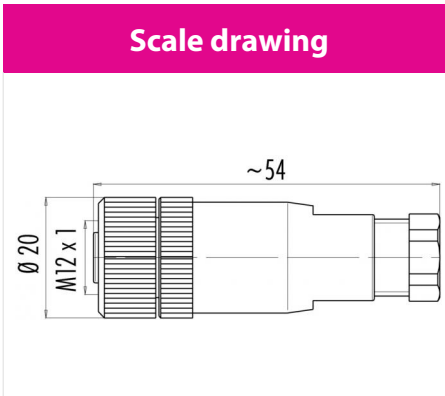

You can find the item description and assembly instruction on the next page.

## Technical data

### Common values

Connector Design	Female cable connector
Connector locking system	screw
Termination	Screwing
Wire gauge (mm)	0.75 mm <sup>2</sup>
Wire gauge (AWG)	18
Cable outlet	4 - 6 mm
Upper temperature	85 °C
Lower temperature	-40 °C

### Cable data

material housing	-
Insulation single lead	-
Single lead structure	-
Conductor resistance	-
Bending radius cable fixed	-
Bending radius cable movable	-

### Electrical values

Rated voltage	250 V
Rated impulse voltage	2500 V
Pollution degree	3
Overtoltage category	II
Material group	III
Rated current (40°C)	4 A
Volume resistivity	≤ 8 mΩ
EMV compliance	not shielded
Degree of protection	IP67
Mechanical operation	> 50 mating cycles

### Material

Material of contact	CuZn (Brass)
Contact plating	CuSnZn (Optaloy)
Material of contact body	PA
Material of housing	PA, nickel-plated zinc die casting/ PA

cable outlet: 4 - 6 mm, Contacts: 4, Female cable connector, plastic lock, screw terminal connection, with UL approval

Product	<b>Contacts: 4, Female cable connector, plastic lock, screw terminal connection, with UL approval</b>	Area	<b>M12-B Series 715</b>
Pole	<b>4</b>	Article number	<b>99 0430 15 04</b>

Item description

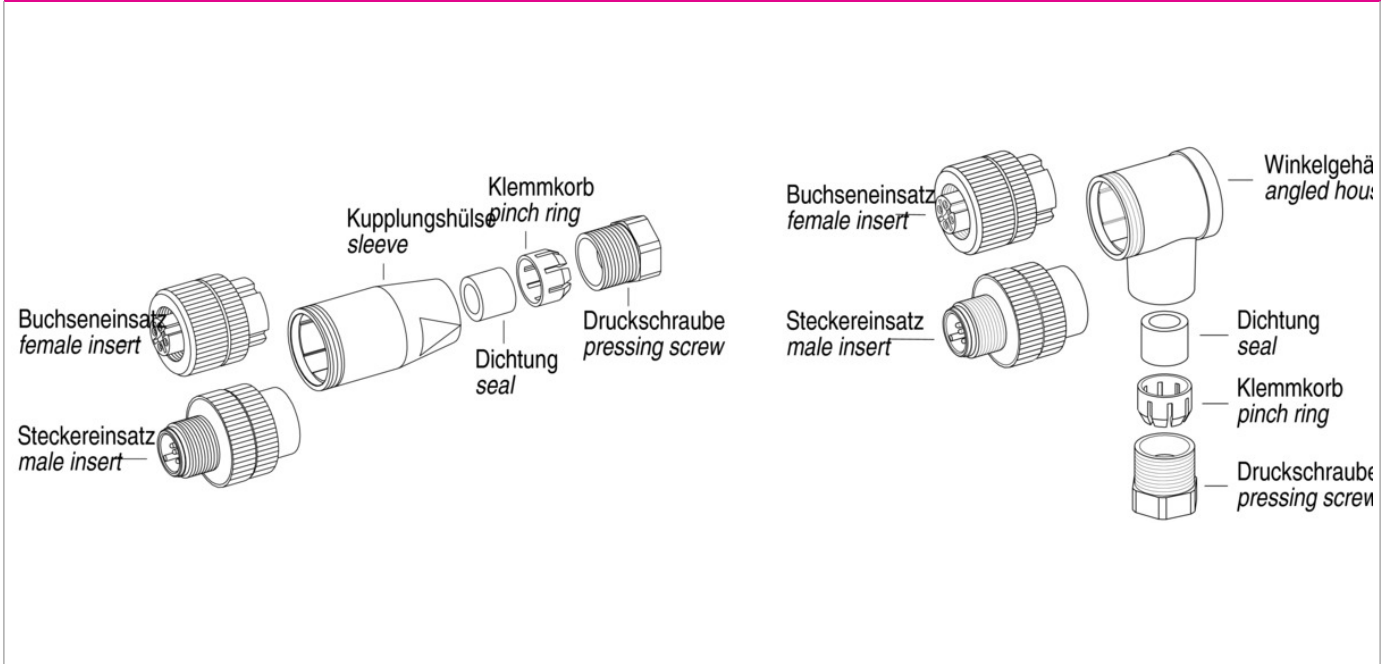

Installation instructions / Mounting cutout

