

Product
Pole

Contacts: 4, Integrated plug for M8 pipe
4

Area
Article number

M8 Series 768/718
09 3389 70 04

Illustration



Scale drawing

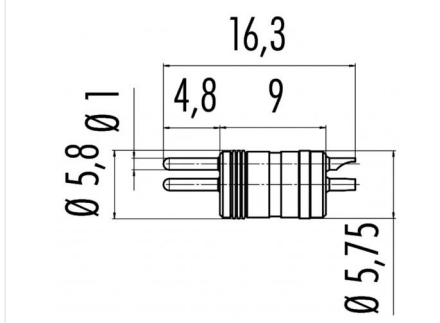

Contact Arrangement

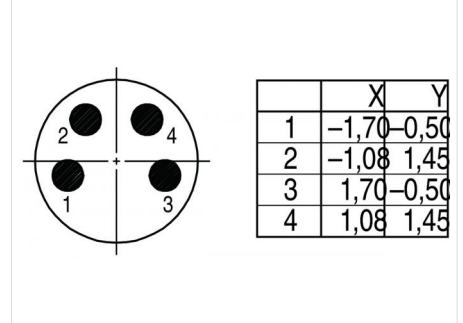

Technical data

Common values

Connector Design	Integrated male connector
Connector locking system	screw
Termination	Solder
Wire gauge (mm)	0.25 mm ²
Wire gauge (AWG)	24
Upper temperature	85 °C
Lower temperature	-40 °C

Electrical values

Rated voltage	30 V
Rated impulse voltage	800 V
Pollution degree	3
Overvoltage category	II
Material group	II
Rated current (40°C)	4 A
Volume resistivity	≤ 3 mΩ
EMV compliance	not shielded
Degree of protection	IP67
Mechanical operation	> 100 mating cycles

Material

Material of contact	CuZn (Brass)
Contact plating	Au (Gold)
Material of contact body	PA (UL 94 HB)
Material of housing	CuZn (Brass nickel-plated)

Contacts: 4, Integrated plug for M8 pipe