

Product sheet

Subminiature connector



Product Pole	Contacts: 5, female cable connector 5	Area Article number	M9 IP40 Series 711 99 0096 102 05
--------------	---	---------------------	---

Illustration



Scale drawing

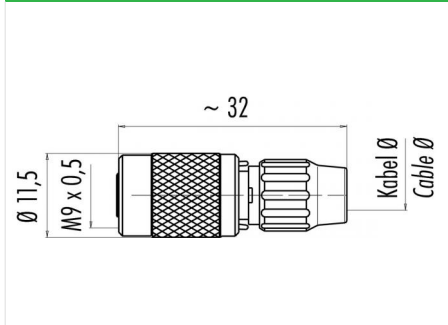

Contact Arrangement

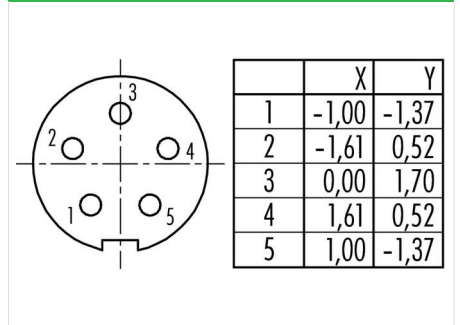

You can find the item description on the next page.

Technical data

Common values

Connector Design	Female cable connector
Connector locking system	screw
Termination	Solder
Wire gauge (mm)	0.25 mm ²
Wire gauge (AWG)	24
Cable outlet	4 - 5 mm
Upper temperature	85 °C
Lower temperature	-40 °C

Cable data

material housing	-
Insulation single lead	-
Single lead structure	-
Conductor resistance	-

Electrical values

Rated voltage	125 V
Rated impulse voltage	1500 V
Pollution degree	1
Overvoltage category	II
Material group	III
Rated current (40°C)	3 A
Volume resistivity	≤ 3 mΩ
EMV compliance	not shieldable
Degree of protection	IP40
Mechanical operation	> 500 mating cycles

Material

Material of contact	CuSn (Bronze)
Contact plating	Au (Gold)
Material of contact body	PA (UL 94 V-0)
Material of housing	PA (UL 94 VH-B)

Contacts: 5, female cable connector, cable outlet 4 - 5 mm

Product
Pole

Contacts: 5, female cable connector
5

Area
Article number

M9 IP40 Series 711
99 0096 102 05

Item description

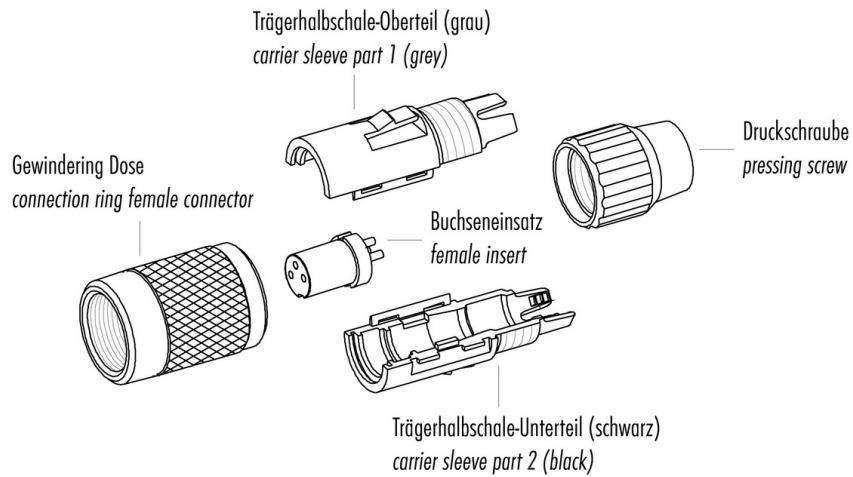

Achtung: max. Drehmoment des Gewindinges im Flanschsteckverbinder: 50cNm (handfest)
Attention: max. torque of ring nut in socket connector: 50cNm (manual adjustment)