

Product **Contacts: 4, Male panel mount connector with single wires, 0,25 mm², contact insert, orange, M16 x 1.5**
 Area **M12-A Series 713/763**
 Article number **76 0231 0011 00204 0200**

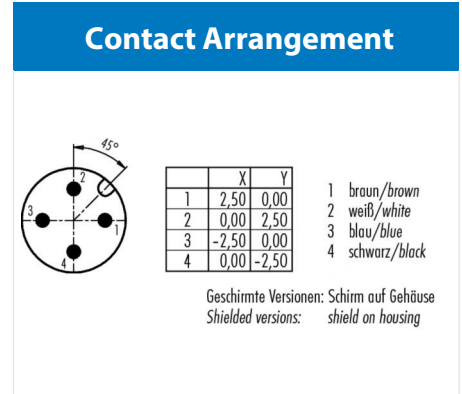
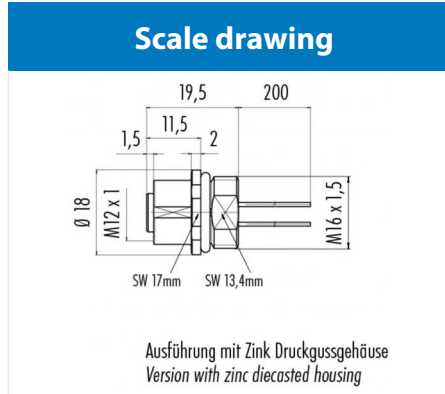
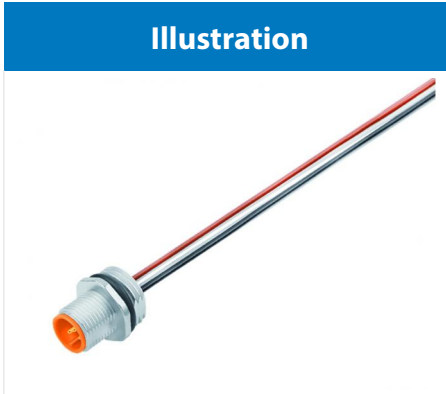

You can find the assembly instruction on the next page.

Technical data

General features

Connector Design male panel mount connector
 Connector locking system bolted
 Termination Strands UL 1007/1569
 Wire gauge (mm) 0,25 mm²
 Wire gauge (AWG) 24
 Upper temperature 85 °C
 Lower temperature -40 °C

Cable data

Approval 1 UL

Electrical parameters

Rated voltage 250 V
 Rated impulse voltage 2500 V
 Pollution degree 3
 Overvoltage category II
 Material group II
 Rated current (40°C) 4 A
 Volume resistivity ≤ 3 mΩ
 EMV compliance not shielded
 Degree of protection IP67
 Mechanical operation > 50 Mating cycles

Material

Material of contact CuZn (Messing)
 Contact plating Au (gold)
 Material of contact body PA
 Material of housing Zink Druckguss vernickelt

Product **Contacts: 4, Male panel mount connector with single wires, 0.25 mm², contact insert, orange, M16 x 1.5**
 Area **M12-A Series 713/763**
 Article number **76 0231 0011 00204 0200**

Installation instructions / Mounting cutout

Mit Fläche als Verdrehschutz
With flats as anti-rotation device

PG 9/M16 x 1,5



Mit Durchgangsbohrung
With bore hole

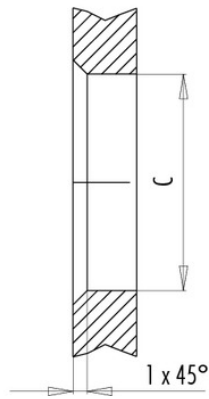

Mit Gewinde, einschraubbar
With thread to screw in



alternativ/alternativ

	A	B	C
PG 9	PG 9	16,2	15,3
PG 13,5	PG 13,5	21,5	20,5
M16x1,5	M16x1,5	17,0	16,1
M20x1,5	M20x1,5	21,0	20,1

Anzugsdrehmoment/Tightening moment

Metallgehäuse/Metal housing 6,25 Nm
 Kunststoffgehäuse/Plastic housing 3,75 Nm