

Product sheet

Subminiature connector



Product	Contacts: 8, Male angled connector, cable outlet 3.5-5 mm	Area	M9 IP67 Series 712
Pole	8	Article number	99 0425 70 08

Illustration



Scale drawing

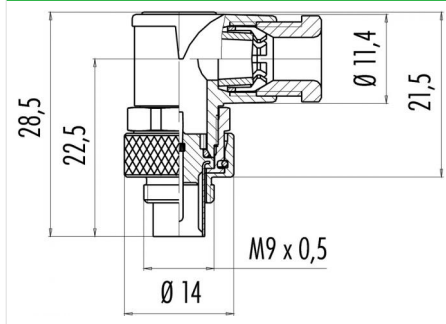

Contact Arrangement

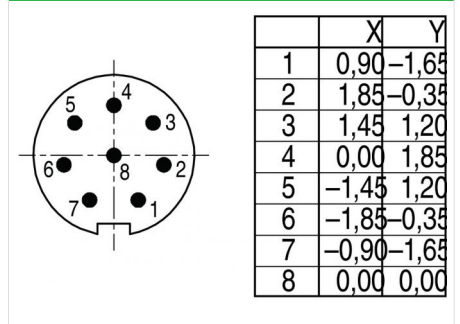

You can find the item description on the next page.

Technical data

Common values

Connector Design	Male angled connector
Connector locking system	screw
Termination	Solder
Wire gauge (mm)	0.14 mm ²
Wire gauge (AWG)	26
Cable outlet	3.5 - 5 mm
Upper temperature	85 °C
Lower temperature	-40 °C

Electrical values

Rated voltage	125 V
Rated impulse voltage	1500 V
Pollution degree	1
Overvoltage category	II
Material group	III
Rated current (40°C)	1 A
Volume resistivity	≤ 3 mΩ
EMV compliance	not shieldable
Degree of protection	IP67
Mechanical operation	> 500 mating cycles

Cable data

material housing	-
Insulation single lead	-
Single lead structure	-
Conductor resistance	-

Material

Material of contact	CuZn (Brass)
Contact plating	Au (Gold)
Material of contact body	PBT (UL 94 V-0)
Material of housing	PA (UL 94 VH-B)

Contacts: 8, Male angled connector, cable outlet 3.5-5 mm

Product

Contacts: 8, Male angled connector, cable outlet 3.5-5 mm
8

Area
Article number

M9 IP67 Series 712
99 0425 70 08

Pole

Item description

