

Product	<b>Contacts: 2+PE, Female angled connector, thread 1/2" UNF with UL approval</b>	Area	<b>M12-US Series 815</b>
Pole	<b>2+PE</b>	Article number	<b>99 2430 52 03</b>

**Illustration**

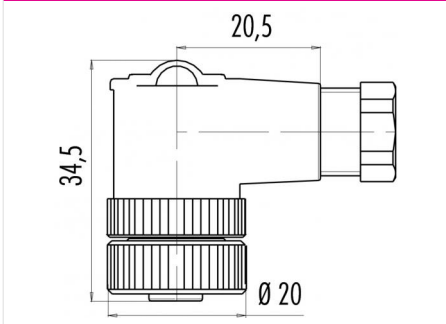

**Scale drawing**



**Contact Arrangement**

	X	Y
1	0,00	1,90
2	1,65	-0,95
3	-1,65	-0,95

You can find the item description and assembly instruction on the next page.

**Technical data**

**Common values**

Connector Design	Female angled connector
Connector locking system	1/2" UNF
Termination	Screwing
Wire gauge (mm)	0.75 mm <sup>2</sup>
Wire gauge (AWG)	18
Cable outlet	6 - 8 mm
Upper temperature	85 °C
Lower temperature	-25 °C

**Electrical values**

Rated voltage	250 V
Rated impulse voltage	2500 V
Pollution degree	3
Overvoltage category	II
Material group	II
Rated current (40°C)	4 A
Volume resistivity	≤ 8 mΩ
EMV compliance	not shielded
Degree of protection	IP67
Mechanical operation	> 50 mating cycles

**Cable data**

material housing	-
Insulation single lead	-
Single lead structure	-
Conductor resistance	-
Bending radius cable fixed	-
Bending radius cable movable	-

**Material**

Material of contact	CuSn (Bronze)
Contact plating	CuSnZn (Optaloy)
Material of contact body	PA
Material of housing	PA

cable outlet: 6 - 8 mm, Contacts: 2+PE, Female angled connector 1/2" UNF, screw, with UL approval

Product	<b>Contacts: 2+PE, Female angled connector, thread 1/2" UNF with UL approval</b>	Area	<b>M12-US Series 815</b>
Pole	<b>2+PE</b>	Article number	<b>99 2430 52 03</b>

Item description

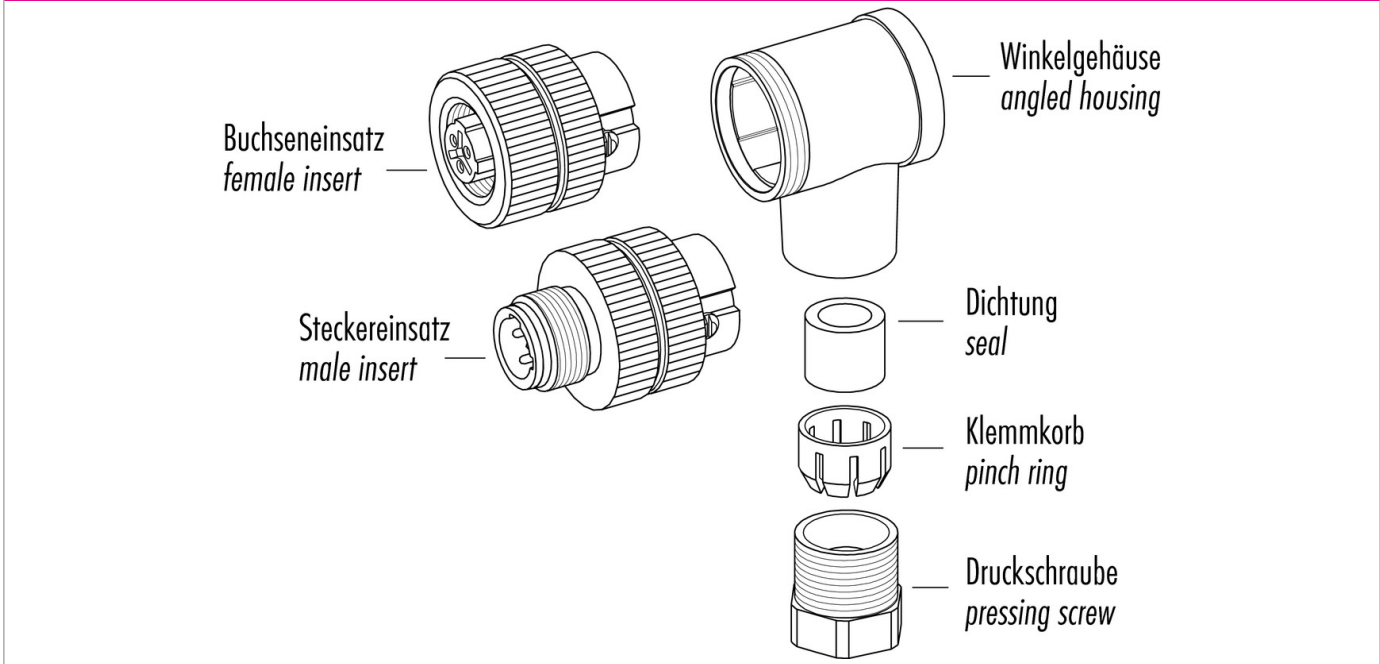

Installation instructions / Mounting cutout

