

Product **female cable connector, overmoulded, stainless steel, PVC cable**

Area **M12-A Series 763 FOOD & BEVERAGE**
Article number **77 3730 0000 20908-0200**

Illustration



Scale drawing

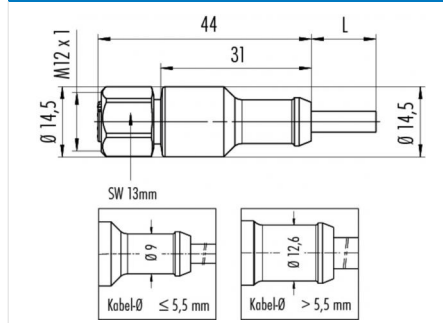

Contact Arrangement

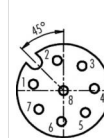

	X	Y
1	-2,69	0,57
2	-0,57	2,69
3	1,66	2,20
4	2,75	0,19
5	1,94	-1,94
6	-0,19	-2,75
7	-2,20	-1,66
8	0,00	0,00

- 1 weiß/white
- 2 braun/brown
- 3 grün/green
- 4 gelb/yellow
- 5 grau/grey
- 6 rosa/pink
- 7 blau/blue
- 8 rot/red

Geschirmte Versionen: Schirm auf Gehäuse oder Pin 8
Shielded versions: shield on housing or pin 8

Technical data

General features

Connector Design	Cable Connector
Connector locking system	screw
Termination	crimp, overmoulded on cable
Wire gauge (mm)	0,25
Wire gauge (AWG)	24
Upper temperature	105 °C
Lower temperature	-40 °C

Cable data

material housing	PVC
Insulation single lead	PVC
Single lead structure	32 x 0,1
Cable sheath Ø	6
Conductor resistance	<79 Ω/Km (20°C)
Temperature range cable movable °C from	-5
Temperature range cable movable °C to	105
Temperature range cable fixed °C from	-40
Temperature range cable fixed °C to	105
Bending radius cable fixed	min. 5 x D
Bending radius cable movable	min. 10 x D
Approval 1	UL listed
Approval 2	Ecolab

Electrical parameters

Rated voltage	30 V
Rated impulse voltage	800 V
Pollution degree	3
Overvoltage category	II
Material group	II
Rated current (40°C)	2 A
Volume resistivity	≤ 3 mΩ
EMV compliance	not shielded
Degree of protection	IP69K
Mechanical operation	> 100 Mating cycles

Material

Material of contact	CuSn (Bronze)
Contact plating	Au (gold)
Material of contact body	PP
Material of housing	PP