

Product	Contacts: 3, Male angled connector, overmoulded, M5x0.5	Area	M5 Series 707
Pole	3	Article number	79 3103 55 03

Illustration

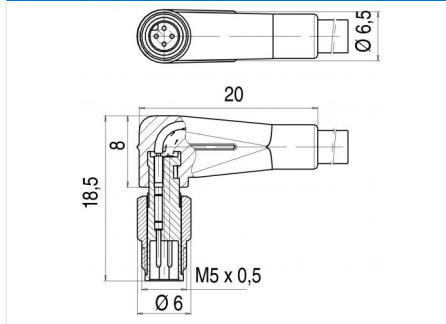

Scale drawing



Contact Arrangement

	X	Y
1	-0,63	-0,63
2	-	-
3	0,63	0,63
4	-0,63	0,63

1 braun/brown
 2 nicht konfektioniert/not assembled
 3 blau/blue
 4 schwarz/black

Technical data

Common values

Connector Design	Male angled connector
Connector locking system	screw
Termination	crimp, injection-moulded cable
Wire gauge (mm)	0.14 mm ²
Wire gauge (AWG)	26
Cable outlet	-
Upper temperature	80 °C
Lower temperature	-25 °C

Cable data

material housing	PUR
Insulation single lead	PVC
Single lead structure	18 x 0.1
Cable sheath Ø	3.1
Conductor resistance	148Ω/Km
Temperature range cable movable c from	-5
Temperature range cable movable c to	80
Temperature range cable fixed c from	-25
Temperature range cable fixed c to	80

Electrical values

Rated voltage	60 V
Rated impulse voltage	800 V
Pollution degree	3
Overvoltage category	II
Material group	I
Rated current (40°C)	1 A
Volume resistivity	≤ 3 mΩ
EMV compliance	nicht geschirmt
Degree of protection	IP67
Mechanical operation	> 100 mating cycles

Material

Material of contact	CuZn (Brass)
Contact plating	Au (Gold)
Material of contact body	PUR
Material of housing	PUR

Contacts: 3, Cable length: 5, Cable: 3 x 0.14 mm² PUR, male angled connector, overmoulded, M5 x 0.5