

Product sheet

Miniature connector



Product	Contacts: 5, Female angled connector, shielded	Area	M16 IP67 Series 425
Pole	5	Article number	79 6314 200 05

Illustration



Scale drawing

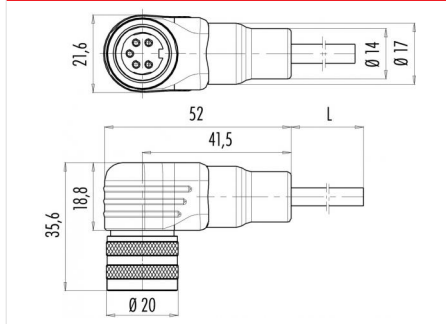

Contact Arrangement

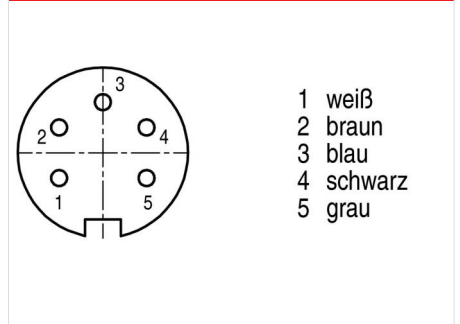

Technical data

Common values

Connector Design	Female angled connector
Connector locking system	screw
Termination	solder, injection-moulded cable
Wire gauge (mm)	0.25 mm ²
Wire gauge (AWG)	24
Cable outlet	-
Upper temperature	70 °C
Lower temperature	-25 °C

Cable data

material housing	PUR
Insulation single lead	PE
Single lead structure	14x0.15 mm
Cable sheath Ø	5.3
Bending radius cable fixed	53 mm
Bending radius cable movable	80 mm
Cable diameter	5.3

Electrical values

Rated voltage	250 V
Rated impulse voltage	1500 V
Pollution degree	1
Overvoltage category	I
Material group	III
Rated current (40°C)	3 A
Volume resistivity	≤ 3 mΩ
EMV compliance	shielded
Degree of protection	IP67
Mechanical operation	> 500 mating cycles

Material

Material of contact	CuSn (Bronze)
Contact plating	Au (Gold)
Material of contact body	PBT (UL 94 V-0)
Material of housing	PUR

Contacts: 5, Cable: 5 x 0.25 mm², female angled connector, shielded