

Product	Contacts: 3+PE, female angled connector with UL approval, cable outlet 8 - 10 mm, 10 - 12 mm	Area	7/8" Series 820
Pole	3+PE	Article number	99 2442 62 04

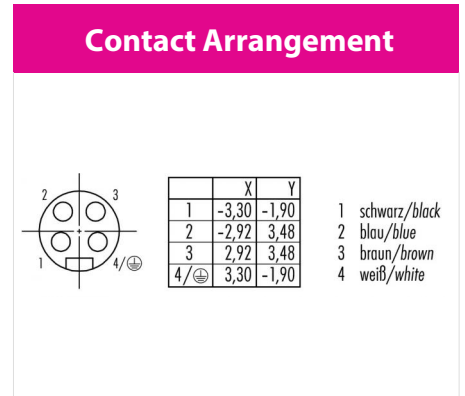
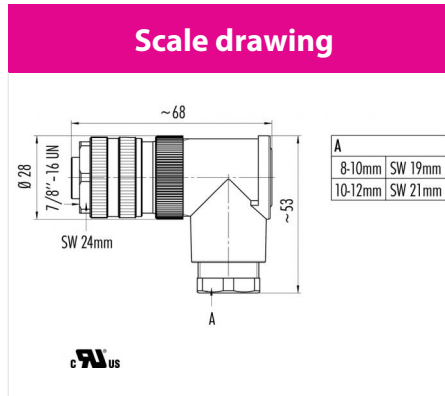

You can find the item description and assembly instruction on the next page.

Technical data

Common values

Connector Design	Female angled connector
Connector locking system	Screws 7/8" - 16 UN
Termination	Screwing
Wire gauge (mm)	1.50 mm ²
Wire gauge (AWG)	16
Cable outlet	8 - 10 mm
Upper temperature	85 °C
Lower temperature	-25 °C

Electrical values

Rated voltage	300 V
Rated impulse voltage	4000 V
Pollution degree	3
Overvoltage category	III
Material group	III
Rated current (40°C)	9 A
Volume resistivity	≤ 3 mΩ
Degree of protection	IP67
Mechanical operation	> 50 mating cycles

Cable data

material housing	-
Insulation single lead	-
Single lead structure	-
Conductor resistance	-
Bending radius cable fixed	-
Bending radius cable movable	-

Material

Material of contact	CuZn (Brass)
Contact plating	Au (Gold)
Material of contact body	PUR, PA (UL 94 HB)
Material of housing	PBT (UL 94 V-0)

cable outlet: 8 – 10 mm, Contacts: 3+PE, female angled connector with UL approval, cross-section 1.5 mm²

Product	Contacts: 3+PE, female angled connector with UL approval, cable outlet 8 - 10 mm, 10 - 12 mm	Area	7/8" Series 820
Pole	3+PE	Article number	99 2442 62 04

Item description

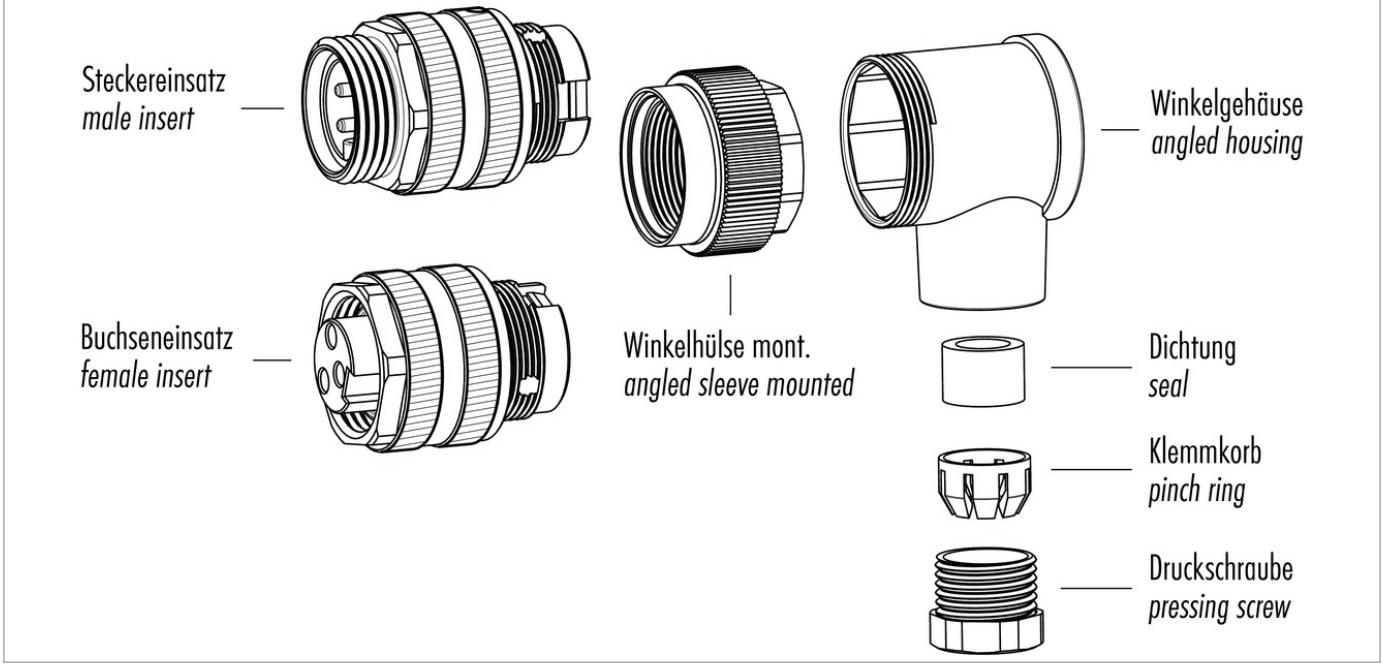

Installation instructions / Mounting cutout

