

Product	Contacts 3: Cable plug connector, overmoulded, M5 x 0.5	Area	M5 Series 707
Pole	3	Article number	79 3101 32 03

Illustration

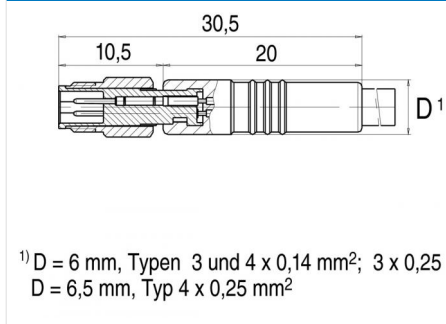

Scale drawing



Contact Arrangement

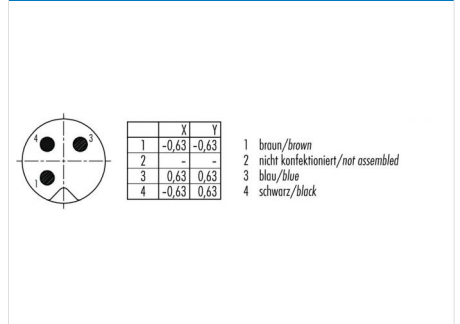

Technical data

Common values

Connector Design	Cable plug connector
Connector locking system	screw
Termination	crimp, injection-moulded cable
Wire gauge (mm)	0,25 mm ²
Wire gauge (AWG)	24
Cable outlet	-
Upper temperature	80 °C
Lower temperature	-25 °C

Cable data

material housing	PUR
Insulation single lead	PVC
Single lead structure	32 x 0.1
Cable sheath Ø	3.7
Conductor resistance	148Ω/Km
Temperature range cable movable c from	-5
Temperature range cable movable c to	80
Temperature range cable fixed c from	-25
Temperature range cable fixed c to	80

Electrical values

Rated voltage	60 V
Rated impulse voltage	800 V
Pollution degree	3
Overvoltage category	II
Material group	I
Rated current (40°C)	1 A
Volume resistivity	≤ 3 mΩ
EMV compliance	nicht geschirmt
Degree of protection	IP67
Mechanical operation	> 100 mating cycles

Material

Material of contact	CuZn (Brass)
Contact plating	Au (Gold)
Material of contact body	PUR
Material of housing	PUR

Contacts 3: Cable length: 2, Cable: 3 x 0.25 mm² PUR, cable plug connector, overmoulded, M5 x 0.5