



inserts:	page:
CDD 24 poles + ⊕	67
CDS 9 poles + ⊕	78
CSH 6 poles + ⊕	91
CNE, CSE 6 poles + ⊕	104
CCE 6 poles + ⊕	110
CSS 6 poles + ⊕	122
CT, CTSE (16A) *) 6 poles + ⊕	130
CQE 10 poles + ⊕	138
MIXO 2 modules	179 - 215

*) only in the CHIN 06 L enclosure

insert centre distance:
44 x 27 mm

housings with single lever



hoods with 2 pegs



description	part No.	entry M	part No.	entry M
bulkhead mounting housing, with lever	CHIN 06 L			
surface mounting housing, high construction, with lever	MAPN 06 L32	32		
with pegs, side entry			MHON 06 L25	25
with pegs, side entry, high construction			MFON 06 L25	25
with pegs, top entry			MHVN 06 L25	25
with pegs, top entry, high construction			MFVN 06 L25	25

panel cut-out for bulkhead mounting housing in mm

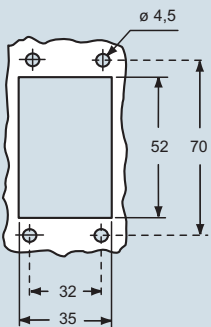

dimensions in mm

CHIN 06 L

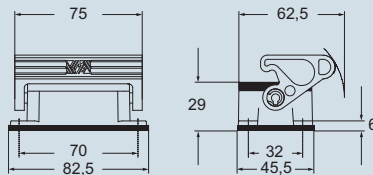

MAPN 06 L32

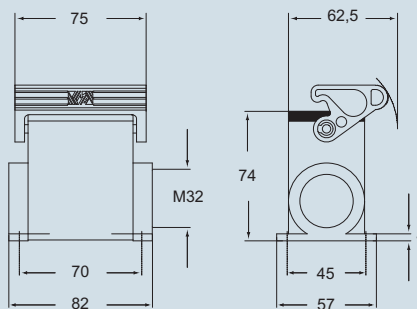

dimensions in mm

MFON 06 L25

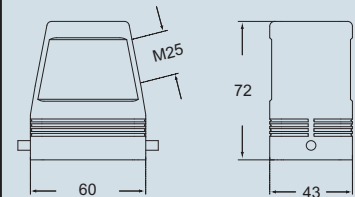

MFVN 06 L25

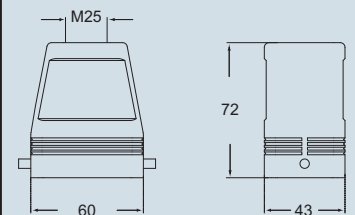

MHON 06 L25

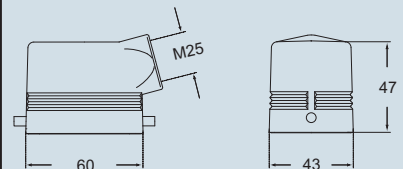

MHVN 06 L25

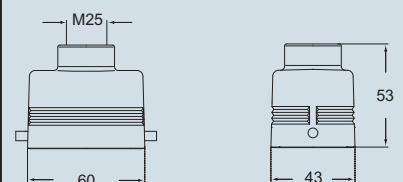

- kiln powder coating with RAL 9005 black epoxy polyester powder
- RAL 9005 black self-extinguishing thermoplastic locking lever (spare lever page 458)

CALUS Type 4/4X/12



dimensions shown are not binding and may be changed without notice

LS-TYPE - size 44.27



inserts:	page:
CDD 24 poles + ⊕	67
CDS 9 poles + ⊕	78
CSH 6 poles + ⊕	91
CNE, CSE 6 poles + ⊕	104
CCE 6 poles + ⊕	110
CSS 6 poles + ⊕	122
CQE 10 poles + ⊕	138
MIXO 2 modules	179 - 215

insert centre distance:
44 x 27 mm

hoods with single lever



covers



description	part No.	entry	part No. (with eyelet)	part No. (with loop)
		M		
with lever and gasket, top entry	MHVN 06 LG25	25		
with lever and gasket, top entry, high construction	MFVN 06 LG25	25		
covers with pegs			CHCN 06 L	
covers with lever				CHCN 06 LG

- kiln powder coating with RAL 9005 black epoxy polyester powder
- RAL 9005 black self-extinguishing thermoplastic locking lever (spare lever page 458)

dimensions in mm

MHVN 06 LG25

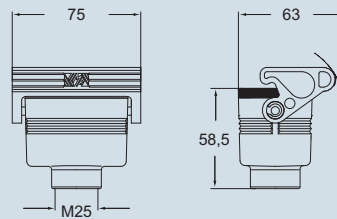

MFVN 06 LG25

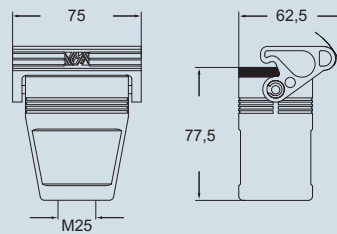

dimensions in mm

CHCN 06 L

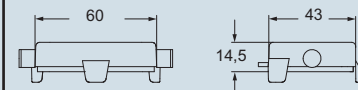

CHCN 06 LG

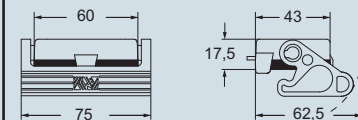

CALUS® Type 4/4X/12



dimensions shown are not binding and may be changed without notice

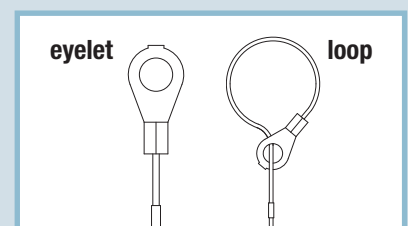

LS-TYPE - size 44.27



inserts:	page:
CDD 24 poles + ⊕	67 *
CDS 9 poles + ⊕	78 *
CSH 6 poles + ⊕	91 *
CNE, CSE 6 poles + ⊕	104 *
CCE 6 poles + ⊕	110 *
CSS 6 poles + ⊕	122 *
CT, CTSE (16A) * .. 6 poles + ⊕	130 *
CQE 10 poles + ⊕	138 *
MIXO 2 modules	179 - 215 *
CDSH 9 poles + ⊕	9
CDSH NC 6 poles + ⊕	19

*) only in the CHIN enclosure

* refer to catalogue page CN.16

insert centre distance:
44 x 27 mm

housings for 1 lever



NEW

hoods with 1 lever



description	part No.	part No.	entry M
bulkhead mounting housing, with 2 pegs	CHIN 06 LCH		
with lever and gasket, top entry		MHVN 06 LG25	25
with lever and gasket, top entry, high construction		MFVN 06 LG25	25

panel cut-out for bulkhead mounting housing in mm

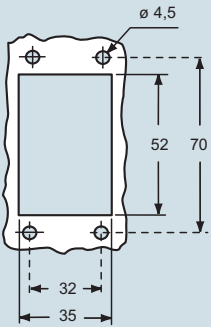

dimensions in mm

CHIN LCH

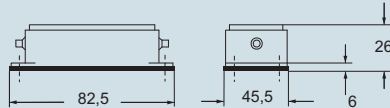

dimensions in mm

MHVN LG

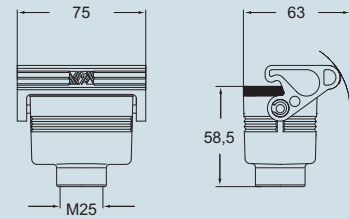

MFVN LG

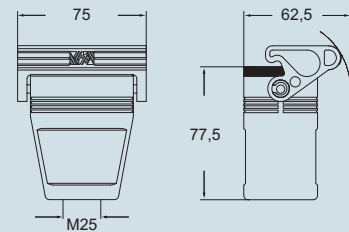

- kiln powder coating with RAL 9005 black epoxy polyester powder
- RAL 9005 black self-extinguishing thermoplastic locking lever (spare lever page 458 catalogue CN.16)



dimensions shown are not binding and may be changed without notice