

Product sheet

Miniature connector

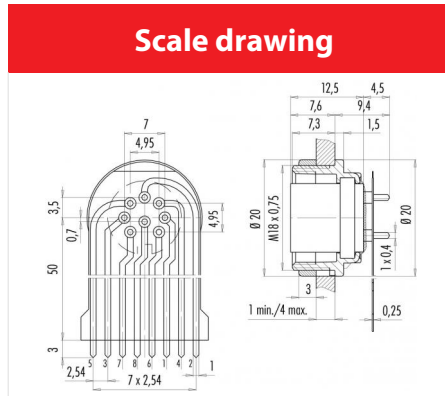

Product	Contacts: 8 DIN, Female panel mount connector with flexible plate, screwed from front, silver plated contacts	Area	M16 IP40 Series 581/ 680/ 682
Pole	8 DIN	Article number	09 0474 65 08

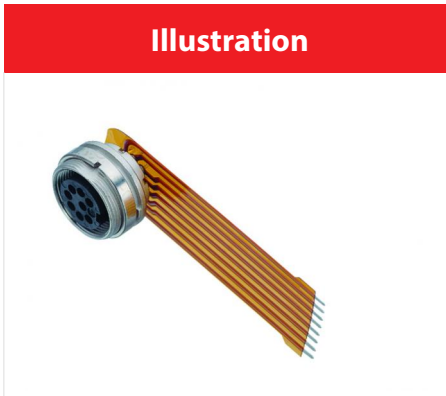

Contact Arrangement

	X	Y
1	-3,50	0,00
2	0,00	3,50
3	3,50	0,00
4	-2,47	2,47
5	2,47	2,47
6	-2,47	-2,47
7	2,47	-2,47
8	0,00	-0,70

You can find the assembly instruction on the next page.

Technical data

Common values

Connector Design	Female panel mount connector
Connector locking system	screw
Wire gauge (mm)	-
Wire gauge (AWG)	-
Upper temperature	85 °C
Lower temperature	-40 °C

Electrical values

Rated voltage	60 V
Rated impulse voltage	500 V
Pollution degree	1
Overvoltage category	I
Material group	III
Rated current (40°C)	5 A
Volume resistivity	≤ 5 mΩ
Degree of protection	IP40
Mechanical operation	> 500 mating cycles

Material

Material of contact	CuSn (Bronze)
Contact plating	Ag (Silver)
Material of contact body	PBT (UL 94 V-0)
Material of housing	Nickel-plated zinc die casting

Contacts: 8 DIN, Female panel mount connector with flexible plate, screwed from front, silver plated contacts

Product	Contacts: 8 DIN, Female panel mount connector with flexible plate, screwed from front, silver plated contacts	Area	M16 IP40 Series 581/ 680/ 682
Pole	8 DIN	Article number	09 0474 65 08

Installation instructions / Mounting cutout

