

Product  
Pole

**Contacts: 4, Male angled connector,  
overmoulded, shielded**  
4

Area  
Article number

**M12-A Series 763**  
**77 3527 0000 20704-0200**

### Illustration



### Scale drawing

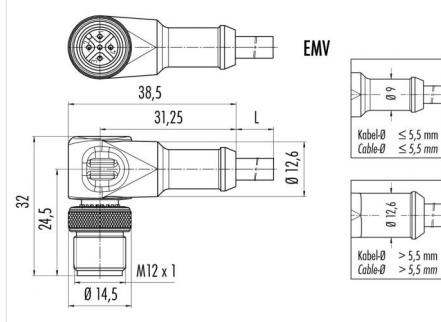

### Contact Arrangement

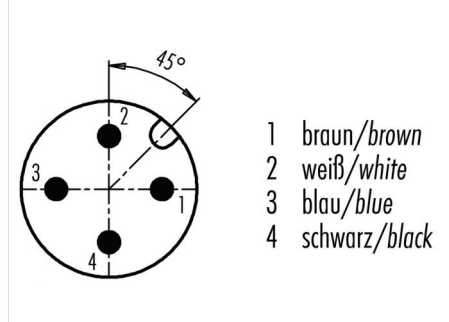

## Technical data

### Common values

Connector Design	Male angled connector
Connector locking system	screw
Termination	crimp, injection-moulded cable
Wire gauge (mm)	0.34 mm <sup>2</sup>
Wire gauge (AWG)	22
Upper temperature	85 °C
Lower temperature	-25 °C

### Cable data

material housing	PVC
Insulation single lead	PVC
Single lead structure	7 x 0.25
Cable sheath Ø	5
Conductor resistance	53Ω/Km
Temperature range cable movable c from	-5
Temperature range cable movable c to	70
Temperature range cable fixed c from	-25
Temperature range cable fixed c to	70
Bending radius cable fixed	25 mm
Bending radius cable movable	50 mm

### Electrical values

Rated voltage	250 V
Rated impulse voltage	2500 V
Pollution degree	3
Overvoltage category	II
Material group	II
Rated current (40°C)	4 A
Volume resistivity	≤ 3 mΩ
EMV compliance	geschirmt
Degree of protection	IP67
Mechanical operation	> 100 mating cycles

### Material

Material of contact	CuZn (Brass)
Contact plating	Au (Gold)
Material of contact body	PUR
Material of housing	PUR

Contacts: 4, Cable length 2 m, cable: 4 x 0.34 mm<sup>2</sup>, PVC, male angled connector, overmoulded, shielded