

Product sheet

Miniature connector



Product	Contacts: 14, Male panel mount connector, screwed from front, shielded, IP 67	Area	Push-Pull IP67 Series 440
Pole	14	Article number	09 4839 81 14

Illustration



Scale drawing

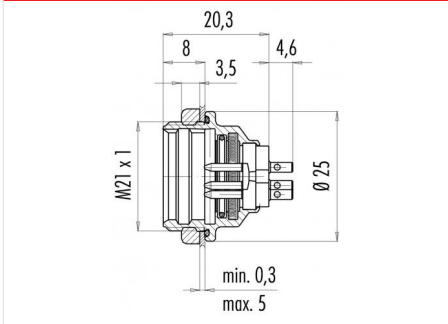

Contact Arrangement

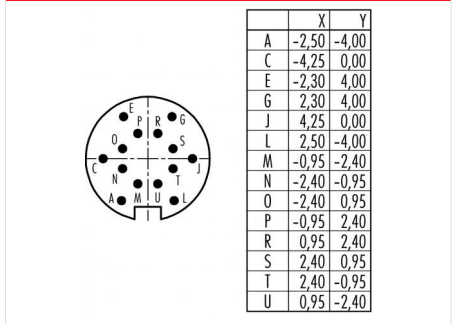

You can find the item description and assembly instruction on the next page.

Technical data

Common values

Connector Design	Male panel mount connector
Connector locking system	Push-Pull
Termination	Solder
Wire gauge (mm)	0.25 mm ²
Wire gauge (AWG)	24
Cable outlet	-
Upper temperature	85 °C
Lower temperature	-40 °C

Electrical values

Rated voltage	60 V
Rated impulse voltage	500 V
Pollution degree	1
Overvoltage category	I
Material group	III
Rated current (40°C)	3 A
Volume resistivity	≤ 3 mΩ
EMV compliance	shielded
Degree of protection	IP67
Mechanical operation	> 1000 mating cycles

Material

Material of contact	CuZn (Brass)
Contact plating	Au (Gold)
Material of contact body	PBT (UL 94 V-0)
Material of housing	CuZn (Brass nickel-plated)

Contacts: 14, Male panel mount connector, screwed from front, shielded, IP 67

Product

Contacts: 14, Male panel mount connector,
screwed from front, shielded, IP 67
14

Area
Article number

Push-Pull IP67 Series 440
09 4839 81 14

Pole

Item description

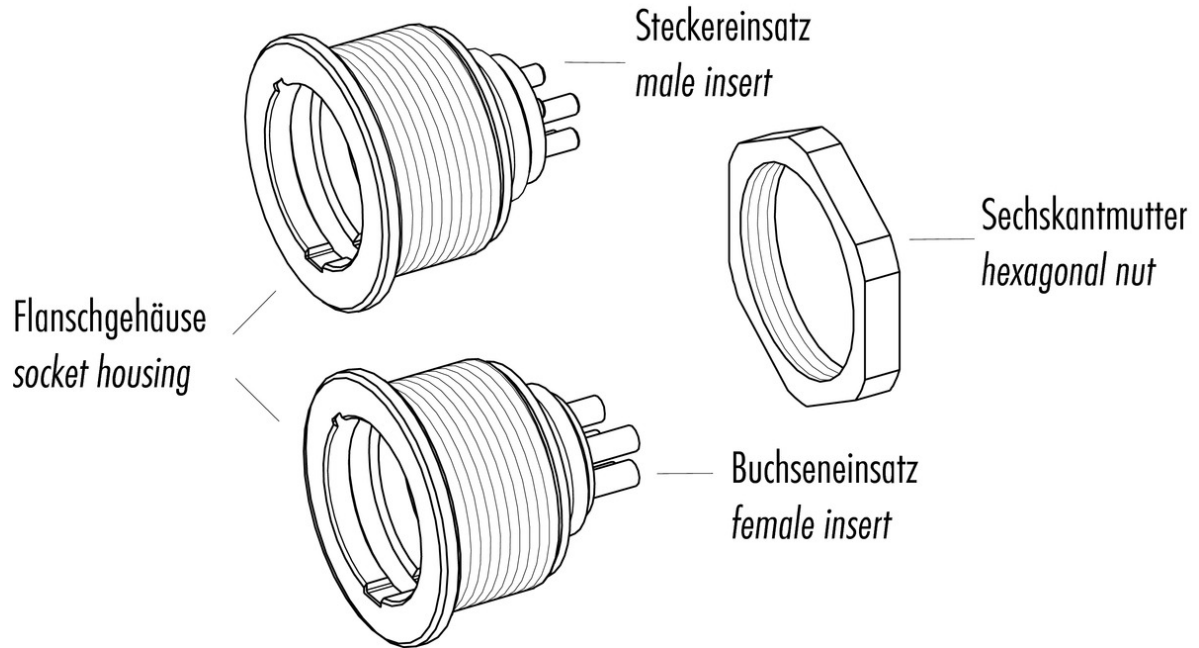

Installation instructions / Mounting cutout

